

Forester 01/98 → 02/08

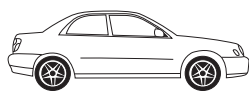

Impreza 01/93 →

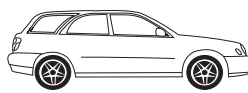

Impreza 01/93 → 09/07

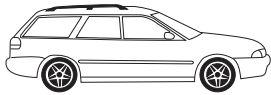

Legacy 01/90 → 08/03

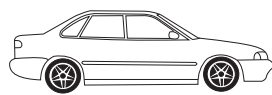

Legacy 01/90 → 08/03

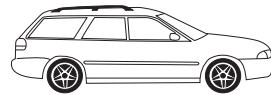

Outback 06/97 → 08/03

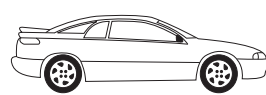

SVX 01/92 →

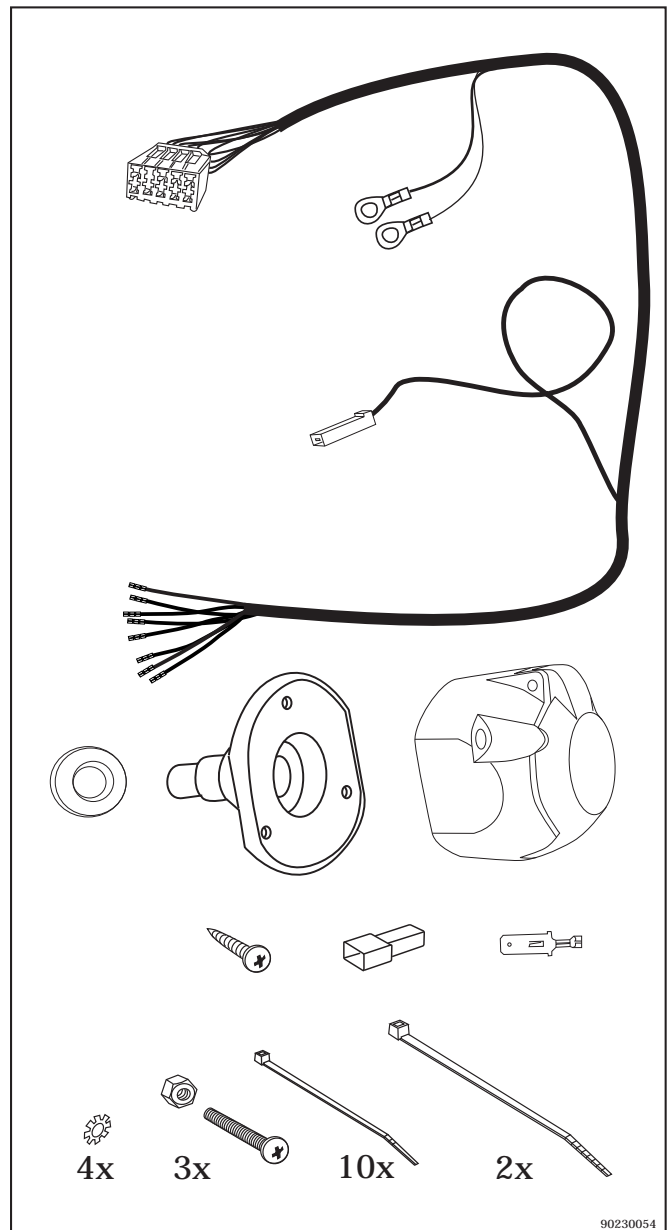
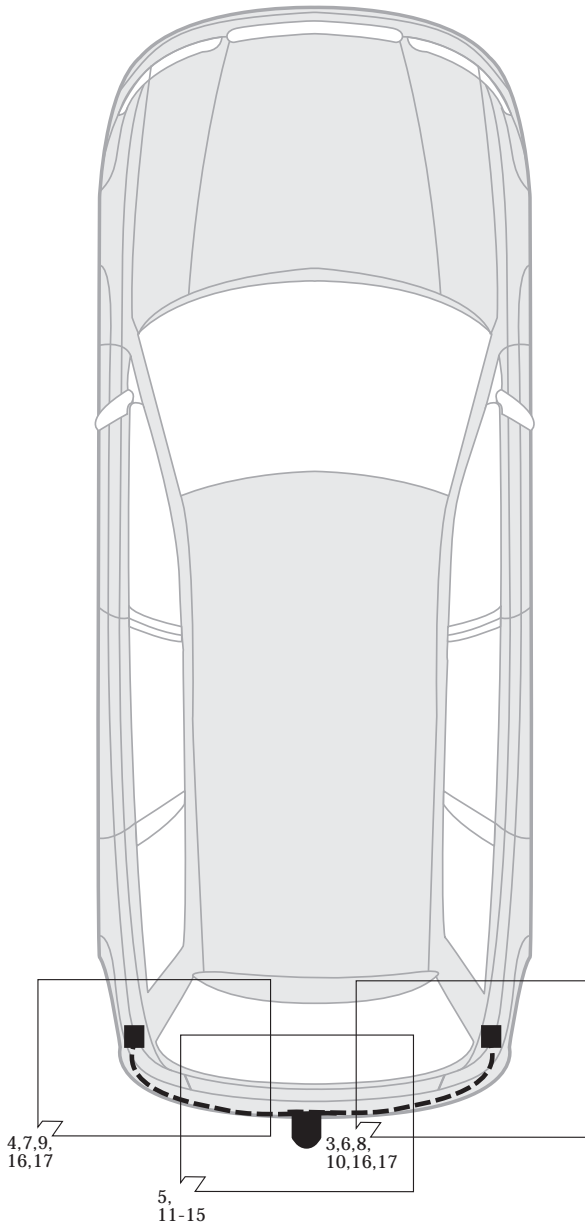

- !** Vor Beginn der Arbeiten unbedingt die Einbauanleitung komplett durchlesen. Nach Einbau des Elektrosatzes ist die Einbauanleitung den Unterlagen des Fahrzeuges beizulegen. Der Einbau des Elektrosatzes muß von einer Fachwerkstatt oder einer entsprechend qualifizierten Person durchgeführt werden. Bei unsachgemäßer Anwendung oder Veränderung des Elektrosatzes bzw. der darin befindlichen Bauteile erlischt jeder Anspruch auf Gewährleistung. Elektronische Bauteile sind vom Umtausch ausgeschlossen. Beim Fahren ohne Anhänger oder Ladungsträger müssen ggf. verwendete Adapter immer aus der Steckdose entfernt werden. Änderungen bezüglich Konstruktion, Ausstattung, Farbe sowie Irrtum vorbehalten. Angaben und Abbildungen unverbindlich. Für technische und elektronische Änderungen, welche nach erstmaliger Inbetriebnahme des Elektrosatzes durchgeführt werden, übernehmen wir keine Verantwortung und Gewährleistung.
- D** Before starting work, you must read the installation instructions through completely. After installing the towing electrics kit, the installation instructions should be kept with the vehicle documentation. Installation of the towing electrics kit must be undertaken by a specialist workshop or an appropriately qualified person. All claims under the guarantee will lapse in case of improper use or modification of the towing electrics kit or any components contained within it. Electronic components can not be exchanged. When driving without a trailer or charge carrier, any adapter installed must be removed from the electrical socket. We reserve the right to alter the design, equipment, colour and any errors. All details and illustrations are nonbinding. We accept no responsibility and give no guarantee for technical and electronic alterations made after the initial operation of the electronic component.
- GB** Avant le début des travaux, lire impérativement les instructions de montage dans leur intégralité. Après le montage du kit électrique, joindre le instructions de montage aux documents du véhicule. Le montage du kit électrique doit être effectué par un atelier spécialisé ou par une personne qualifiée en la matière. Un usage inapproprié ou des modifications du kit électrique, ou des pièces qui le composent, entraînent l'expiration de tout droit à la garantie. Les composants électroniques ne sont ni repris ni échangés. Lors d'une conduite sans remorque ou porteur de charge, les adaptateurs utilisés doivent, le cas échéant, toujours être enlevés de la prise de courant. Sous réserve de modifications de construction, équipement, couleurs ou erreur. Données et illustrations sous toute réserve. Nous n'assumons aucune responsabilité ni garantie pour les modifications techniques et électroniques ayant été effectuées après la première mise en service du groupe électrique.
- F** Prima di iniziare i lavori leggere attentamente le istruzioni di montaggio. Dopo aver installato il kit elettrico si prega di allegare queste istruzioni ai documenti dell'autoveicolo. L'installazione del kit elettrico deve essere effettuata esclusivamente da un'officina o da personale specializzato. La garanzia non copre le parti che risultano difettose a causa di modifiche al kit elettrico o a componenti del medesimo. La garanzia non copre i danni risultanti da un uso inappropriato del kit elettrico. Le componenti elettroniche non possono essere sostituite. Durante la guida senza rimorchio o portacarichi, togliere gli adattatori utilizzati dalla presa di corrente. Con riserva di modifiche relative a costruzione, equipaggiamento, colore nonché salvo errori. Indicazioni e illustrazioni non sono vincolanti. Per le modifiche tecniche ed elettroniche che vengono eseguite dopo la prima messa in esercizio del kit elettrico non assumiamo alcuna responsabilità e garanzia.
- I**

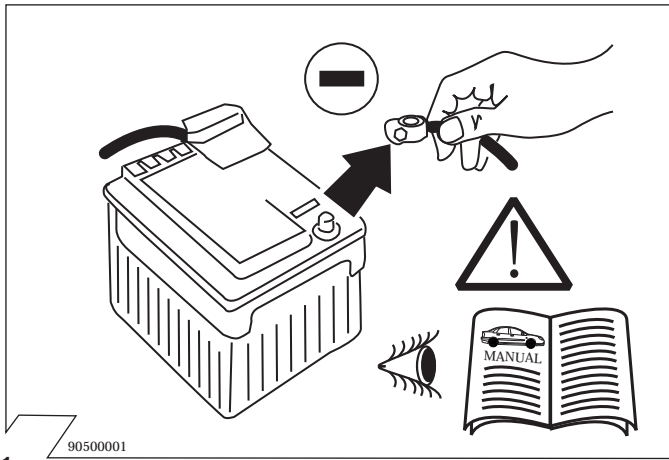

1

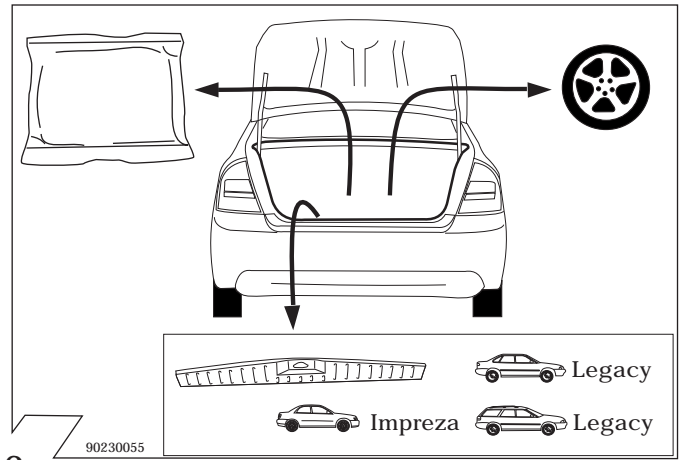

2

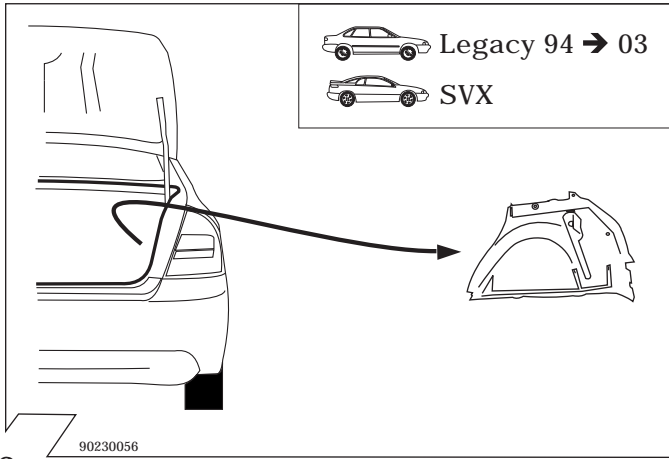

3

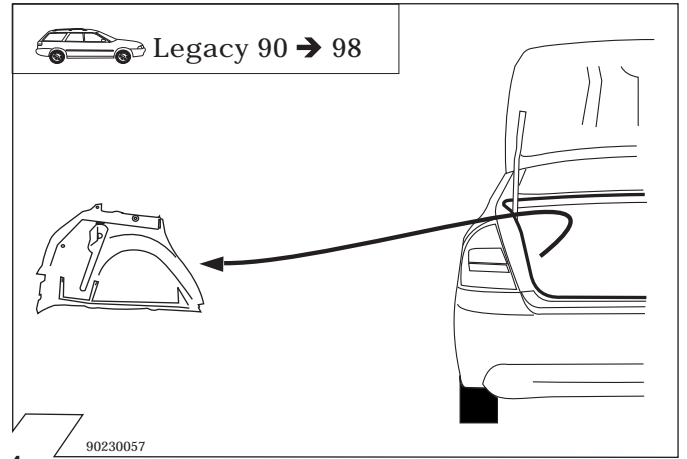

4

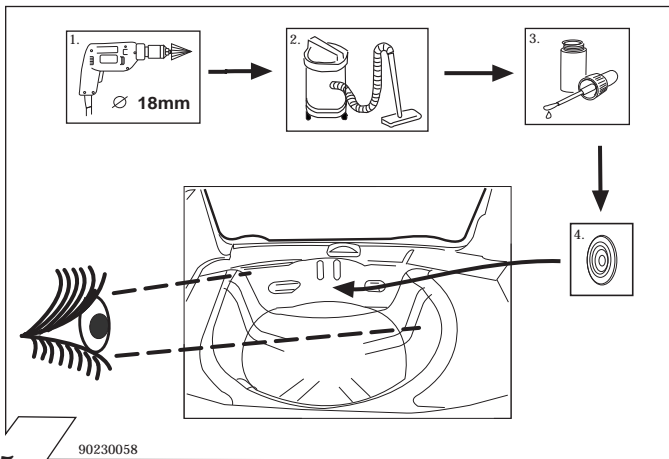

5

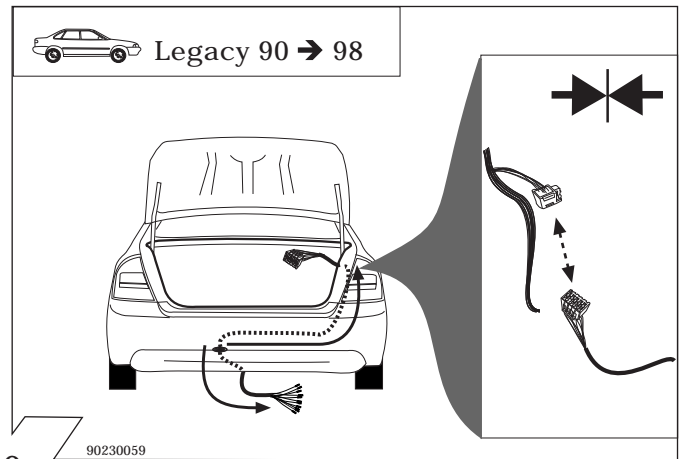

6

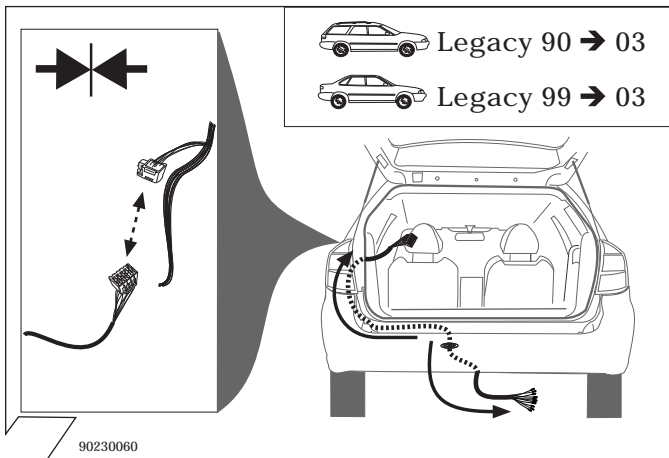

7

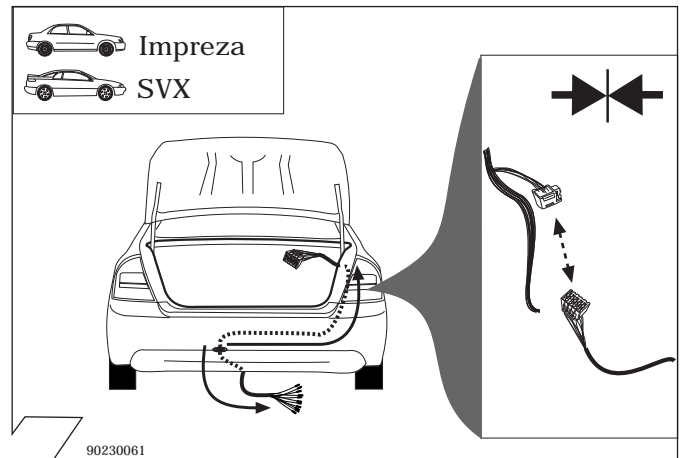

8

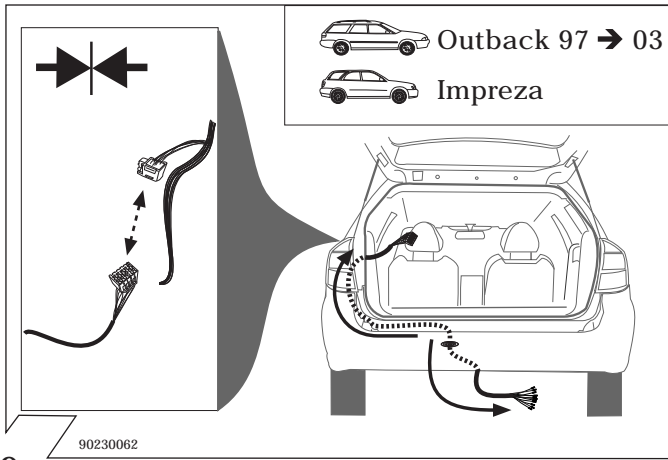

9

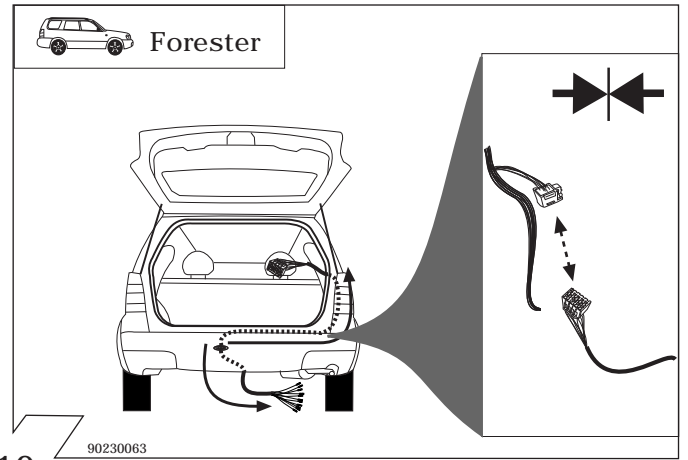

10

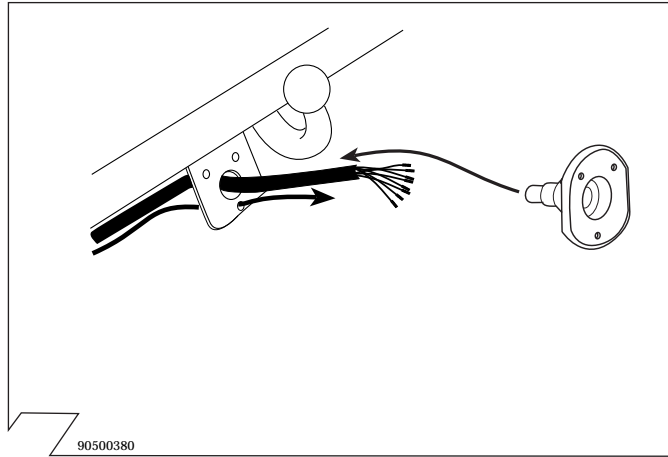

11

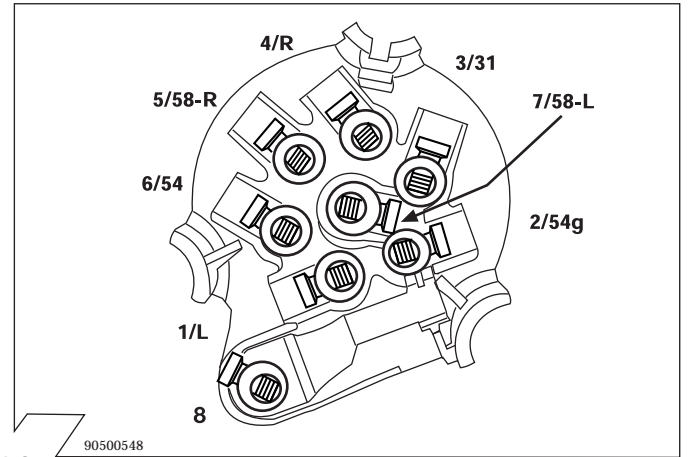

12

| | (GB) | (D) | (E) | (F) | (I) | (P) | (NL) | (DK) | (N) | (S) | (FIN) | (CZ) | (H) | (PL) |
|----|--------|---------|----------|--------|-----------|-------------|--------|--------|---------|---------|-----------|----------|-----------|--------------|
| BK | Black | Schwarz | Negro | Noir | Nero | Preto | Zwart | Sort | Svart | Svart | Musta | Černá | Fekete | Czarny |
| RD | Red | Rot | Rojo | Rouge | Rosso | Vermelho | Rood | Rød | Rød | Röd | Punainen | Červená | Piros | Czerwony |
| GN | Green | Grün | Verde | Vert | Verde | Verde | Groen | Grøn | Grønt | Grön | Vihreä | Zelená | Zöld | Zielony |
| OR | Orange | Orange | Naranja | Orange | Arancione | Laranja | Oranje | Orange | Orange | Orange | Oranssi | Oranžová | Narancs | Pomarańczowy |
| VT | Violet | Violett | Violeta | Violet | Viola | Violeta | Violet | Violet | Fiolett | Violett | Violetti | Fialová | Ibolya | Fioletowy |
| PK | Pink | Pink | Pink | Rose | Rosa | Cor-de-Rosa | Paars | Pink | Pink | Rosa | Pinkki | Růžová | Rózsaszín | Różowy |
| BL | Blue | Blau | Azul | Bleu | Blu | Azul | Blauw | Blå | Blått | Blå | Sininen | Modrá | Kék | Niebieski |
| YL | Yellow | Gelb | Amarillo | Jaune | Giallo | Amarelo | Geel | Gul | Gult | Gul | Keltainen | Žlutá | Sárga | Żółty |
| WT | White | Weiss | Blanco | Blanc | Bianco | Branco | Wit | Hvid | Hvitt | Vit | Valkoinen | Bílá | Fehér | Biały |
| BR | Brown | Braun | Marrón | Brun | Marrone | Marrom | Bruin | Brun | Brunt | Brun | Ruskea | Hnědá | Barna | Brazowy |
| GY | Grey | Grau | Gris | Gris | Grigio | Cinzeno | Grijs | Grå | Grått | Grå | Harmaa | Šedá | Szürke | Szary |

90500580

13

| ISO 1724 | Belegung der Steckdose/Socket Configuration Correspondance des Contacts de la prise Cavi della presa elettrica sono abbinati | | |
|----------|--|-------|--|
| | 1/L | BK/WT | |
| | 2 | WT | |
| | 3/31 | BR | |
| | 4/R | BK/GN | |
| | 5/58-R | GY/RD | |
| | 6/54 | BK/RD | |
| | 7/58-L | GY/BK | |
| | 8 | BK | |

90500591

14

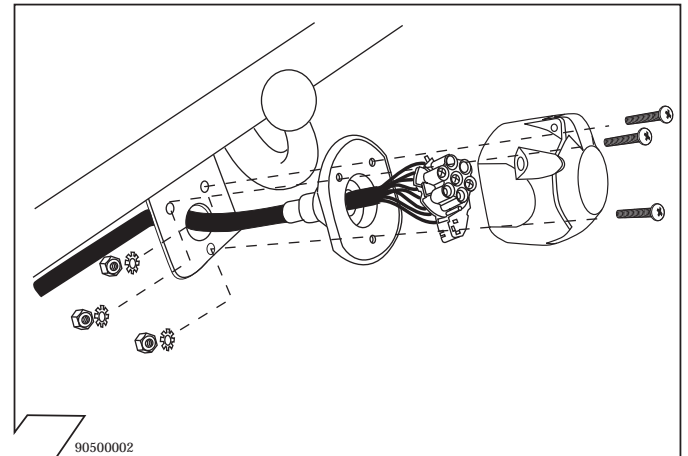

15

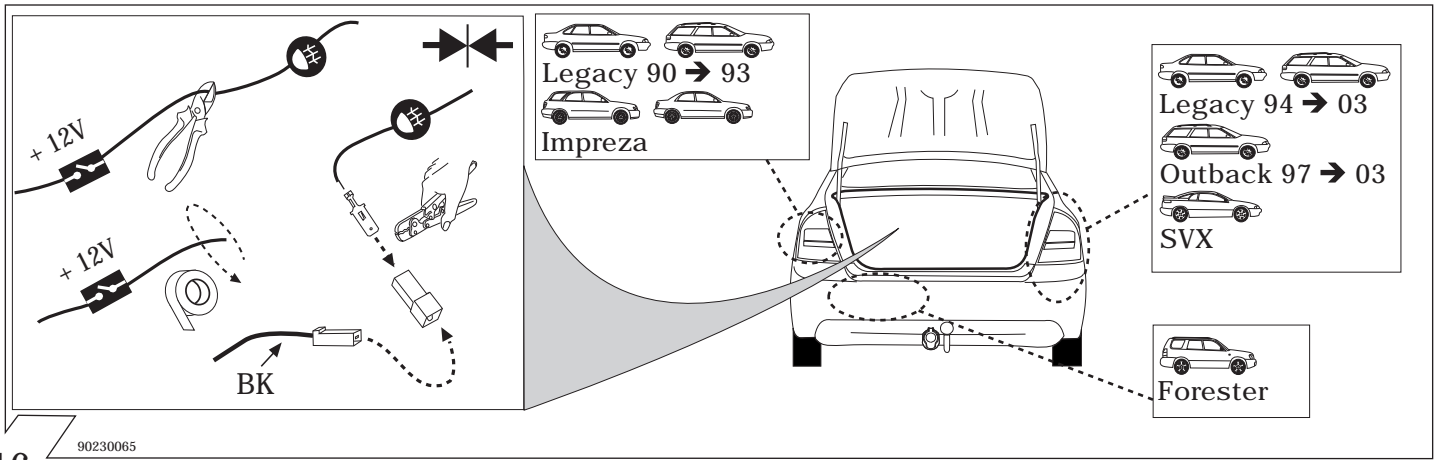

16

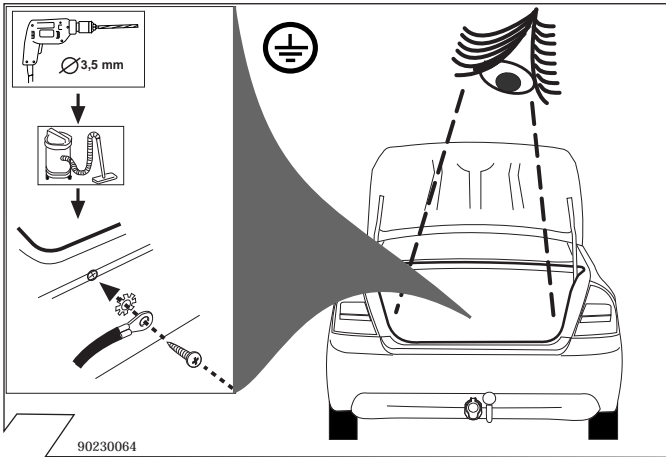

17

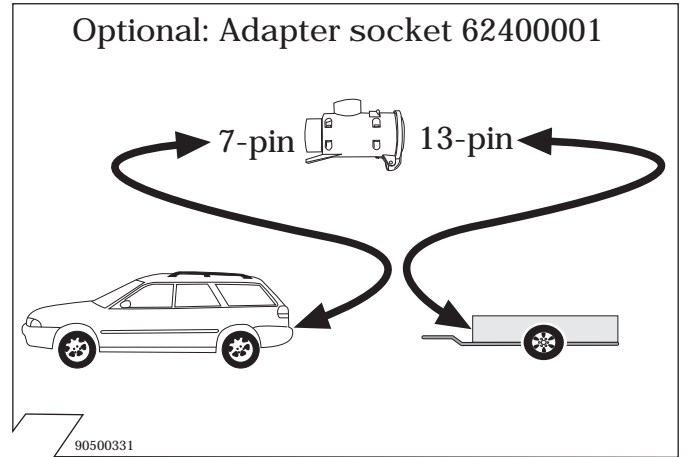

18

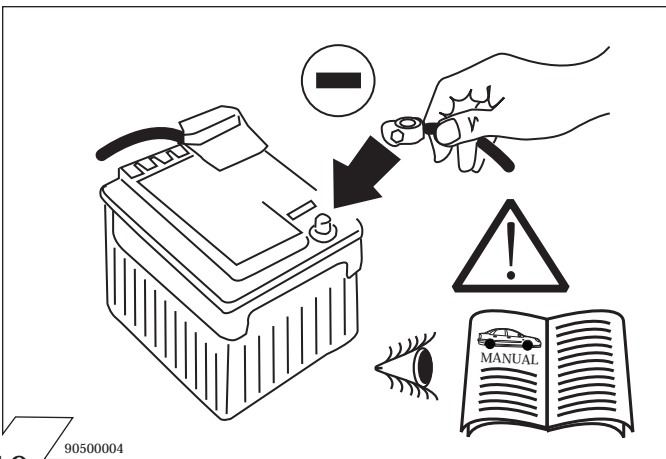

19

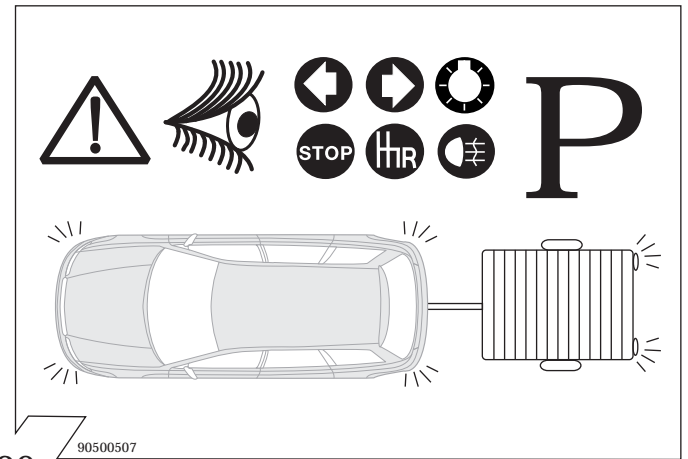

20

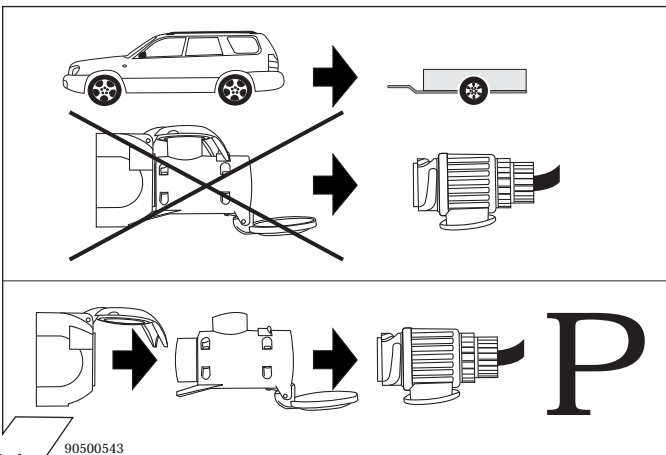

21