

Avensis Verso

07/01 →

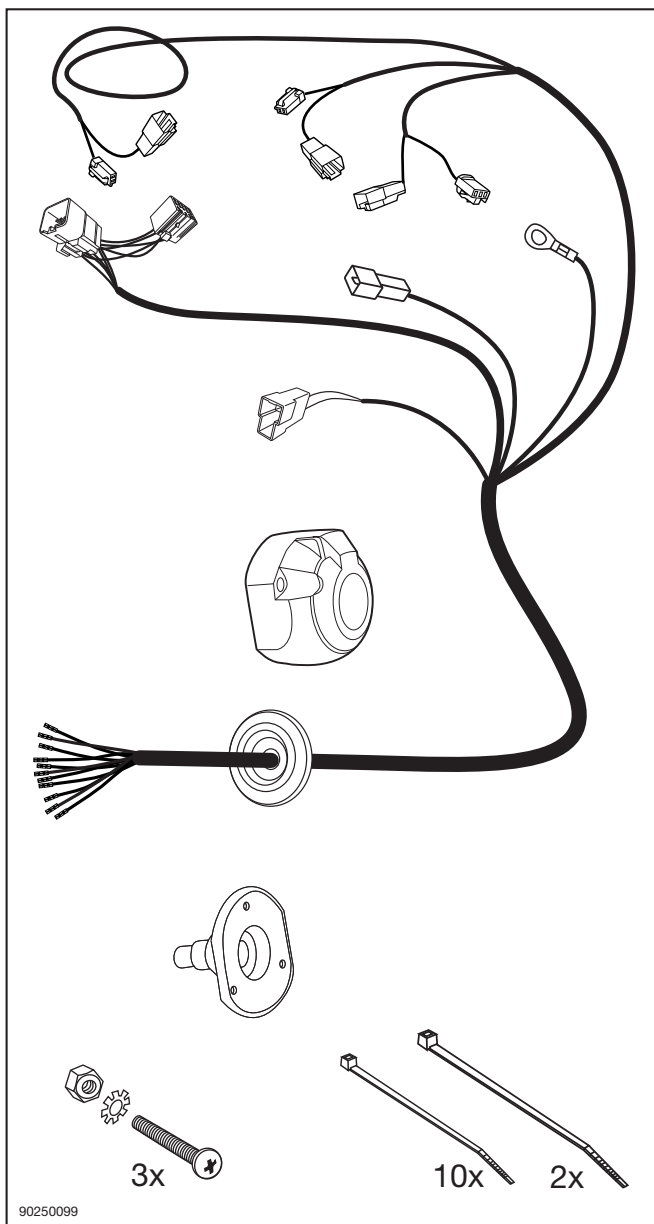

- ⚠** Vor Beginn der Arbeiten unbedingt die Einbauanleitung komplett durchlesen. Nach Einbau des Elektrosatzes ist die Einbauanleitung den Unterlagen des Fahrzeuges beizulegen. Der Einbau des Elektrosatzes muß von einer Fachwerkstatt oder einer entsprechend qualifizierten Person durchgeführt werden. Bei unsachgemäßer Anwendung oder Veränderung des Elektrosatzes bzw. der darin befindlichen Bauteile erlischt jeder Anspruch auf Gewährleistung. Elektronische Bauteile sind vom Umtausch ausgeschlossen. Beim Fahren ohne Anhänger oder Ladungsträger müssen ggf. verwendete Adapter immer aus der Steckdose entfernt werden. Änderungen bezüglich Konstruktion, Ausstattung, Farbe sowie Irrtum vorbehalten. Angaben und Abbildungen unverbindlich. Für technische und elektronische Änderungen, welche nach erstmaliger Inbetriebnahme des Elektrosatzes durchgeführt werden, übernehmen wir keine Verantwortung und Gewährleistung.
- D** Before starting work, you must read the installation instructions through completely. After installing the towing electrics kit, the installation instructions should be kept with the vehicle documentation. Installation of the towing electrics kit must be undertaken by a specialist workshop or an appropriately qualified person. All claims under the guarantee will lapse in case of improper use or modification of the towing electrics kit or any components contained within it. Electronic components can not be exchanged. When driving without a trailer or charge carrier, any adapter installed must be removed from the electrical socket. We reserve the right to alter the design, equipment, colour and any errors. All details and illustrations are nonbinding. We accept no responsibility and give no guarantee for technical and electronic alterations made after the initial operation of the electronic component.
- ⚠** Avant le début des travaux, lire impérativement les instructions de montage dans leur intégralité. Après le montage du kit électrique, joindre le instructions de montage aux documents du véhicule. Le montage du kit électrique doit être effectué par un atelier spécialisé ou par une personne qualifiée en la matière. Un usage inapproprié ou des modifications du kit électrique, ou des pièces qui le composent, entraînent l'expiration de tout droit à la garantie. Les composants électroniques ne sont ni repris ni échangés. Lors d'une conduite sans remorque ou porteur de charge, les adaptateurs utilisés doivent, le cas échéant, toujours être enlevés de la prise de courant. Sous réserve de modifications de construction, équipement, couleurs ou erreur. Données et illustrations sous toute réserve. Nous n'assumons aucune responsabilité ni garantie pour les modifications techniques et électroniques ayant été effectuées après la première mise en service du groupe électrique.
- F** Prima di iniziare i lavori leggere attentamente le istruzioni di montaggio. Dopo aver installato il kit elettrico si prega di allegare queste istruzioni ai documenti dell'autoveicolo. L'installazione del kit elettrico deve essere effettuata esclusivamente da un'officina o da personale specializzato. La garanzia non copre le parti che risultano difettose a causa di modifiche al kit elettrico o a componenti del medesimo. La garanzia non copre i danni risultanti da un uso inappropriato del kit elettrico. Le componenti elettroniche non possono essere sostituite. Durante la guida senza rimorchio o portacarichi, togliere gli adattatori utilizzati dalla presa di corrente. Con riserva di modifiche relative a costruzione, equipaggiamento, colore nonché salvo errori. Indicazioni e illustrazioni non sono vincolanti. Per le modifiche tecniche ed elettroniche che vengono eseguite dopo la prima messa in esercizio del kit elettrico non assumiamo alcuna responsabilità e garanzia.
- I**

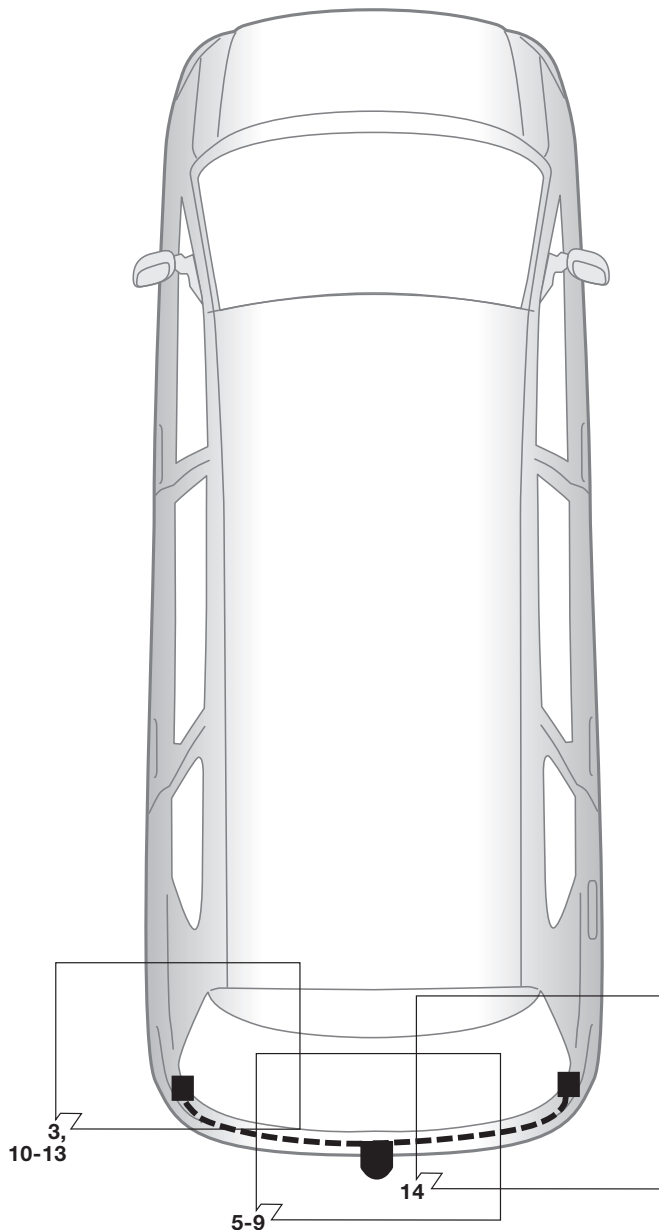
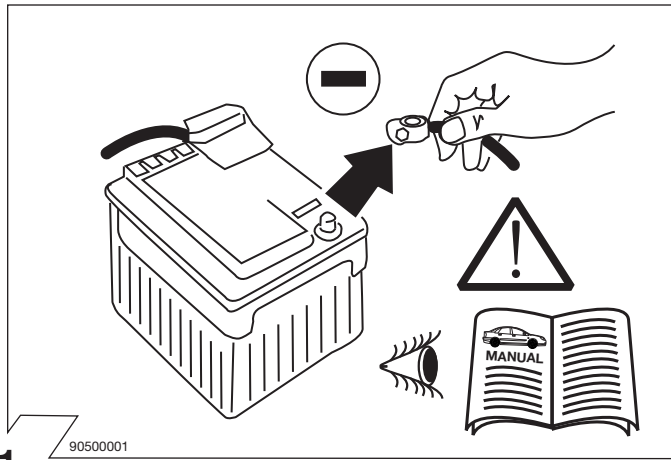

1

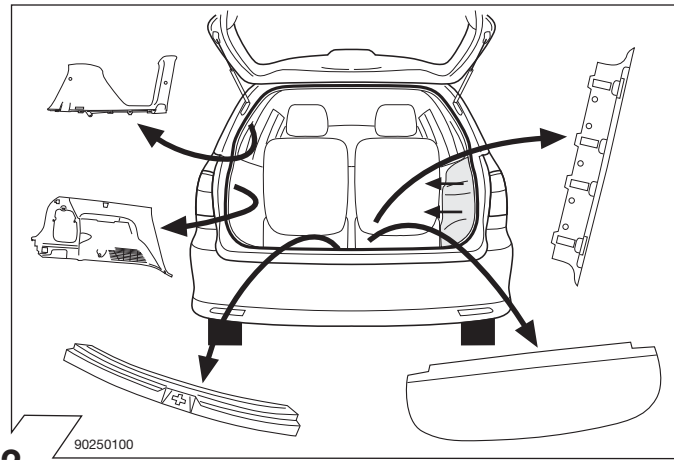

2

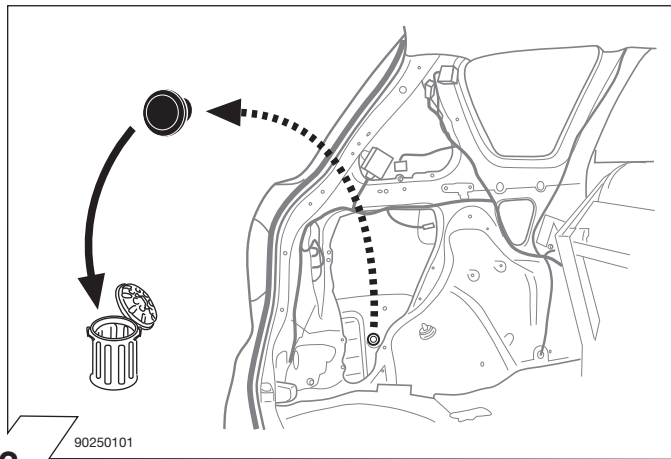

3

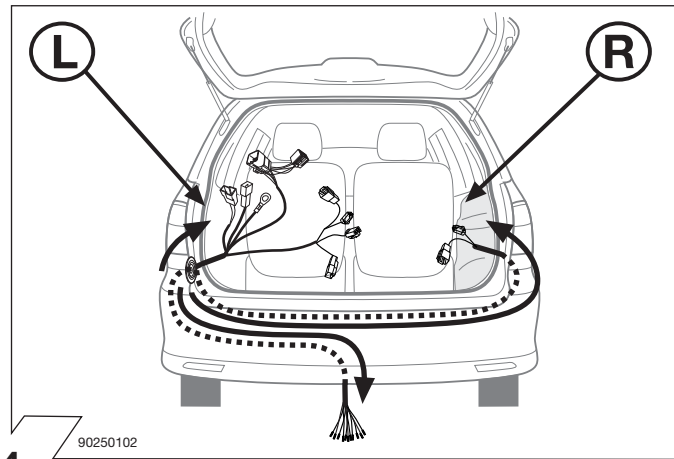

4

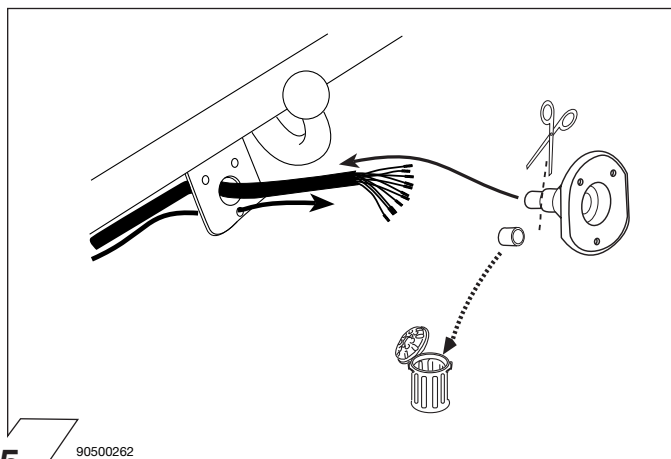

5

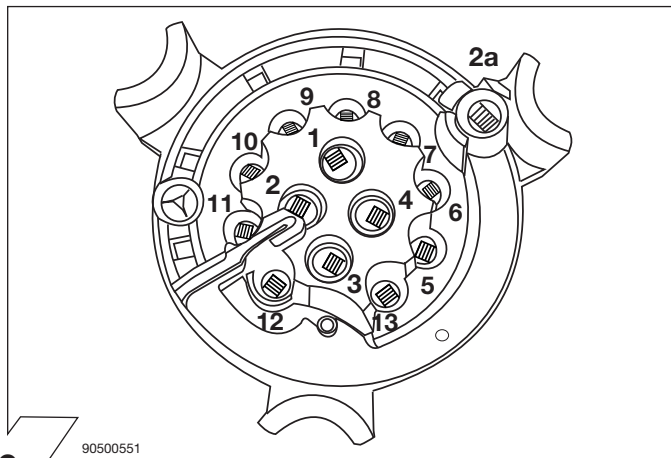

6

ISO 11446	Belegung der Steckdose/Socket Configuration Correspondance des Contacts de la prise Cavi della presa elettrica sono abbinati	
	1/L	BK/WT
	2	WT
	2a	BK
	3/31	BR
	4/R	BK/GN
	5/58-R	GY/RD
	6/54	BK/RD
	7/58-L	GY/BK
	8	BL/RD
	9	RD
	10	YL
	11	YL/BR
	12	
	13	RD/BR

7

	GB	D	E	F	I	P	NL	DK	N	S	FIN	CZ	H	PL
BK	Black	Schwarz	Negro	Noir	Nero	Preto	Zwart	Sort	Svart	Svart	Musta	Černá	Fekete	Czarny
RD	Red	Rot	Rojo	Rouge	Rosso	Vermelho	Rood	Rød	Röd	Röd	Punainen	Červená	Piros	Czerwony
GN	Green	Grün	Verde	Vert	Verde	Verde	Groen	Grøn	Grønt	Grön	Vihreä	Zelená	Zöld	Zielony
OR	Orange	Orange	Naranja	Orange	Arancione	Laranja	Oranje	Orange	Orange	Orange	Oranssi	Oranžová	Narancs	Pomarańczowy
VT	Violet	Violett	Violeta	Violet	Viola	Violeta	Violet	Violet	Fiolett	Violett	Violetti	Fialová	Ibolya	Fioletowy
PK	Pink	Pink	Pink	Rose	Rosa	Cor-de-Rosa	Paars	Pink	Pink	Rosa	Pinkki	Růžová	Rózsaszín	Różowy
BL	Blue	Blau	Azul	Bleu	Blu	Azul	Blauw	Blå	Blått	Blå	Sininen	Modrá	Kék	Niebieski
YL	Yellow	Gelb	Amarillo	Jaune	Giallo	Amarelo	Geel	Gul	Gult	Gul	Keltainen	Žlutá	Sárga	Żółty
WT	White	Weiss	Blanco	Blanc	Bianco	Branco	Wit	Hvid	Hvitt	Vit	Valkoinen	Bílá	Fehér	Biały
BR	Brown	Braun	Marrón	Brun	Marrone	Marrom	Bruin	Brun	Brunt	Brun	Ruskea	Hnědá	Barna	Brazowy
GY	Grey	Grau	Gris	Gris	Grigio	Cinzeno	Grijs	Grå	Grått	Grå	Harmaa	Šedá	Szürke	Szary

90500580

8

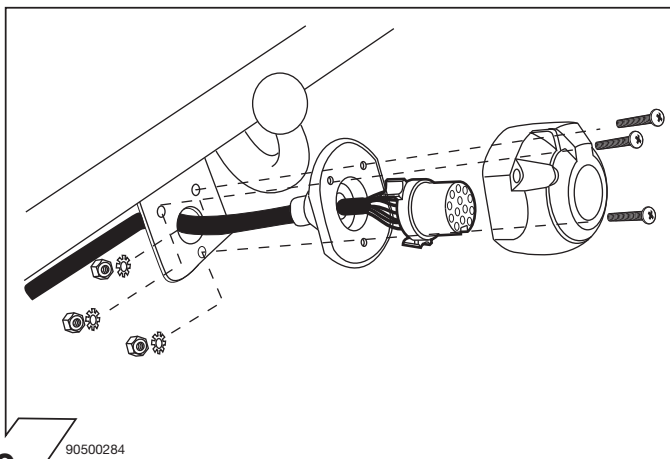

90500284

9

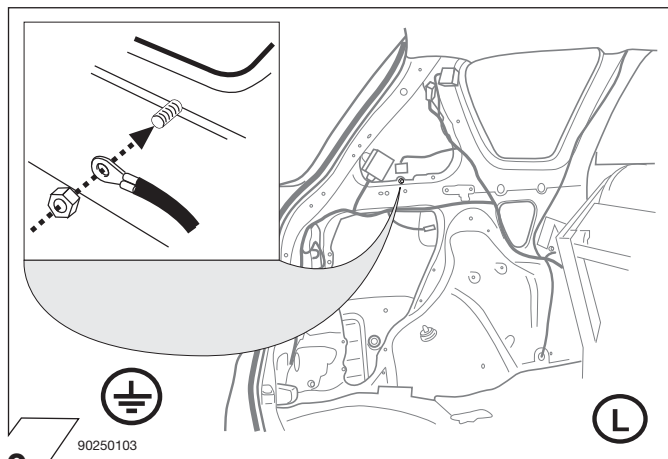

90250103

10

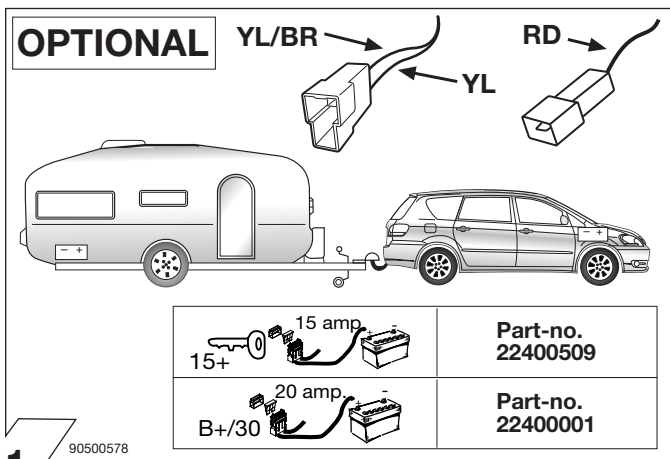

90500578

11

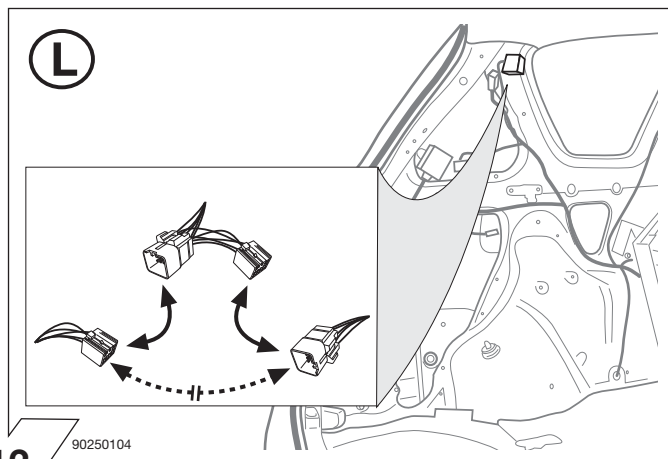

90250104

12

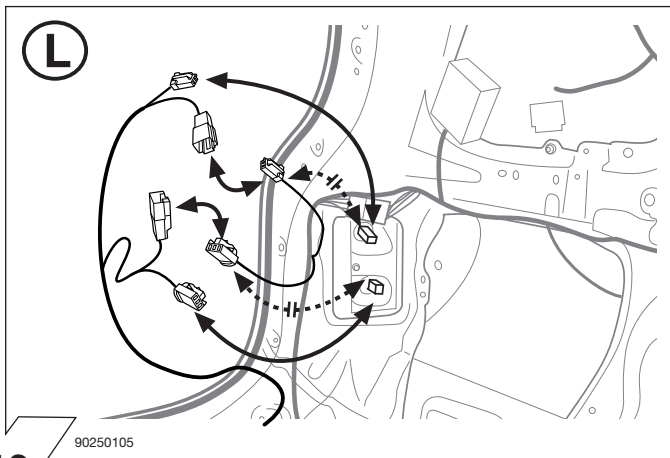

90250105

13

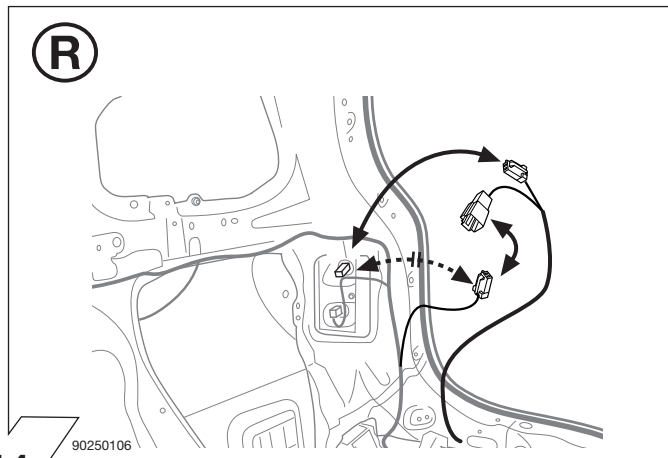

90250106

14

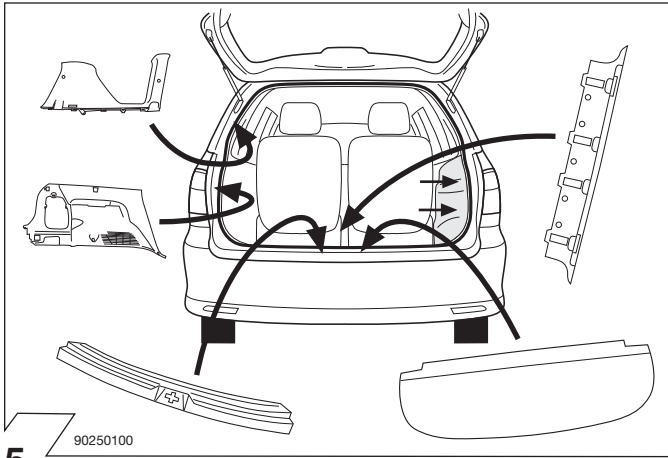

15

90250100

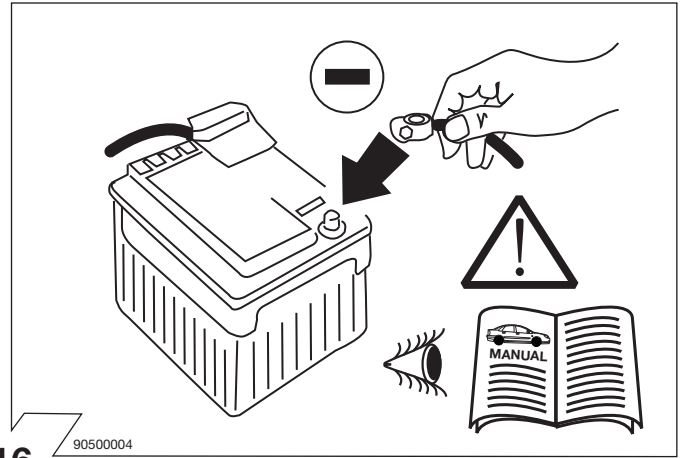

16

90500004

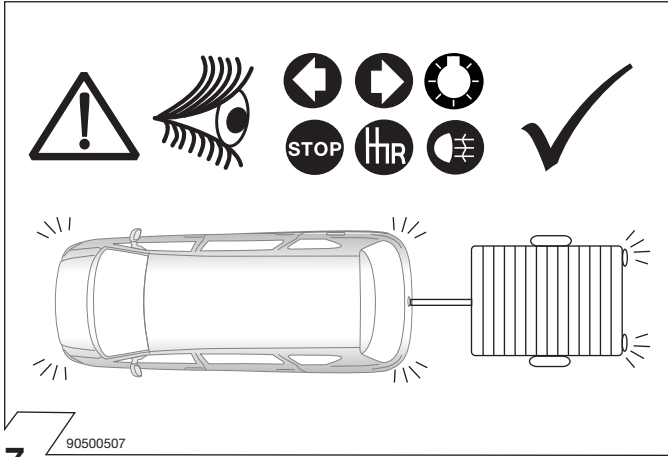

17

90500507

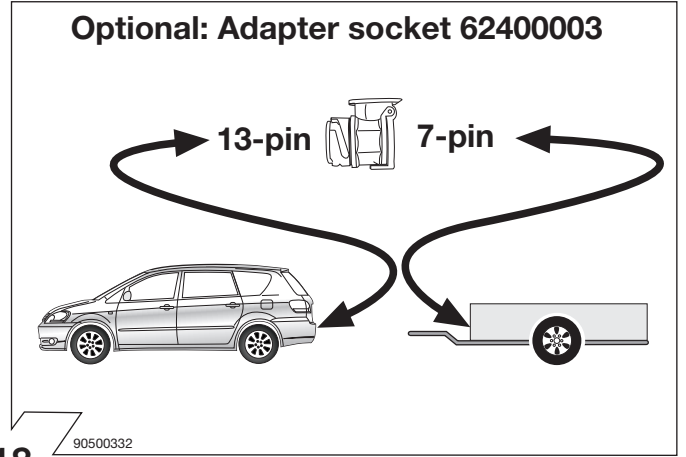

18

90500332

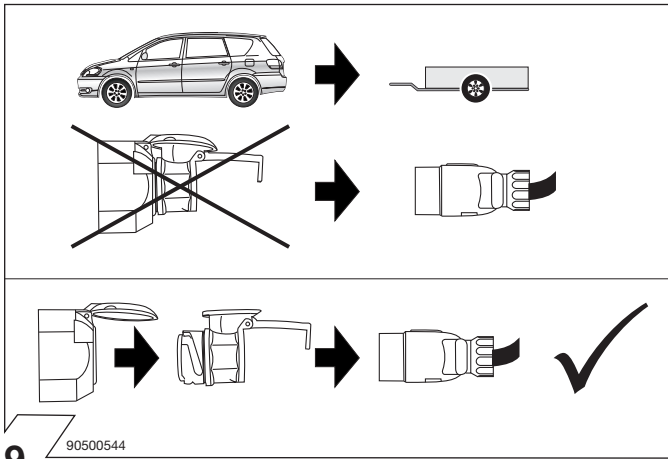

19

90500544