

ES	Instrucción de montaje ¡Leer primero!	Barras de aluminio
EN	Assembly instructions Read first!	Aluminium bars
FR	Instruction de montage Lire en premier!	Barres d'aluminium
DE	Montageanleitung Zuerst lesen!	Aluminiumdachträger
PT	Instruções de montagem Ler primeiro!	Barras d'alumínio
IT	Istruzioni di montaggio Leggere per primo!	Barre di alluminio
NL	Montagehandleiding Eerst lezen!	Aluminium dakdragers
PL	Instrukcja montażu Najpierw przeczytaj!	Belki aluminiowe
CZ	Montážní návod Čtěte pozorně!	Hliníková sada tyčí
HU	Szerelési Utasítás Először olvassd el!	Alumínium rudak
HR	Detaljne upute Prvo procitaj!	Bare din aluminiu
RO	Instructiuni de montaj Intai cititi!	Aluminijske šipke
RU	Инструкции по монтажу Сначала прочитайте!	Алюминиевые поперечины
GR	Διαβάστε προσεκτικά τις Οδηγίες Συναρμολόγησης!	Μπάρες Αλουμινίου
TR	Öncelikle montaj: Talimatlarını okuyunuz!	Alüminyum barlar
SI	Navodila za sestavljanje Preberite!	Aluminijske prečke

924-09XAF3

Lv7 2018-r1

Modelo-model:

CRUZAlu Cargo AF3

Lote-Lot-Lot-Lot:



Peso-Weight-Poids-Gewicht:

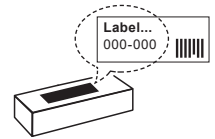

Max. 150 kg / 330 lbs

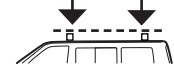

CEE - EEC type approval:



26 R- 04 3022



CITY CRASH (M)

CRUZBER SAU
ES-A14018311
P.I. Las Salinas II
14960 - Rute - Spain
www.cruz-products.com



1.

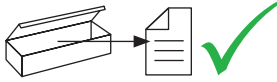

ES Contenido embalaje: ¡Verificar!

x1

x1

EN Package content: Check!



FR Contenu d'emballage: Vérifier!

DE Packungsinhalt: Überprüfen!

x3

PT Contéudo embalagem:
Verificar!

IT Contenuto della confezione:
Controllare!

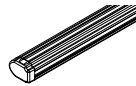

NL Pakket inhoud: Controleer!

PL Zawartość opakowania:
sprawdź!

CZ Obsah balení: Zkontrolujte!

HU Csomag tartalma: Ellenőrizd!

HR Sadržaj paketa: Provjeri!





RO Pachetul contine: Verificati!

RU Содержание упаковки:
Проверьте!

GR Ελέγξτε το περιεχόμενο του
πακέτου!

TR Paket içeriğini: Control ediniz!

SI Vsebina paketa: Preverite!

Código Code					Lote Lot
924-072	AF 118 (824-062)	118 cm / 46"	3x (749-066) 1x (749-054)	4,68 kg / 10,32 lbs	02/23
924-095	AF 128 (824-064)	128 cm / 50"	3x (749-067) 1x (749-054)	5,44 kg / 11,99 lbs	03/23
924-096	AF 138 (824-069)	138 cm / 54"	3x (749-069) 1x (749-054)	5,84 kg / 12,88 lbs	03/23
924-097	AF 148 (824-074)	148 cm / 58"	3x (749-070) 1x (749-054)	6,28 kg / 13,85 lbs	04/23
924-098	AF 158 (824-079)	158 cm / 62"	3x (749-071) 1x (749-054)	6,64 kg / 14,64 lbs	03/23
924-099	AF 175 (824-084)	175 cm / 69"	3x (749-073) 1x (749-054)	7,05 kg / 15,54 lbs	02/23

2.



Importante!
Important!
Important!
Wichtig!

- ES Estas barras tienen que usarse con Kits de fijación CRUZ!
- EN Bars must be used with CRUZ fixation Kits!
- FR Les barres devront être utilisées avec les Kits de fixation CRUZ!
- DE Die Dachträger nur mit CRUZ Stützfuß-Kits befestigen!
- PT As barras devem ser utilizadas com os Kits de fixação CRUZ!
- IT Questa bare deve essere utilizzato solo con il kit di fissaggio CRUZ!
- NL Dakdragers moeten worden gebruikt in combinatie met de bevestigingssets van CRUZ!

- PL Belki muszą być stosowane z elementami mocującymi firmy CRUZ!
- CZ Tento nosič musí být používán s fixačním kitem CRUZ!
- HU A rudakat csak CRUZ rögzítő készlettel szabad használni!
- HR Šipke moraju biti korištene sa CRUZ kitovima za montažu!
- RO Barele trebuie utilizate cu Kit-uri de fixare CRUZ!
- RU Поперечины должны быть использованы со специальным крепежным комплектом CRUZ!
- GR Το αξεσουάρ αυτό θα πρέπει να χρησιμοποιείται αποκλειστικά στα συστήματα μπαρών της CRUZ!
- TR Bu barlar mutlak CRUZ montaj kiti!
- SI Prečke je potrebno uporabiti s CRUZ kiti za pričvrščanje

1

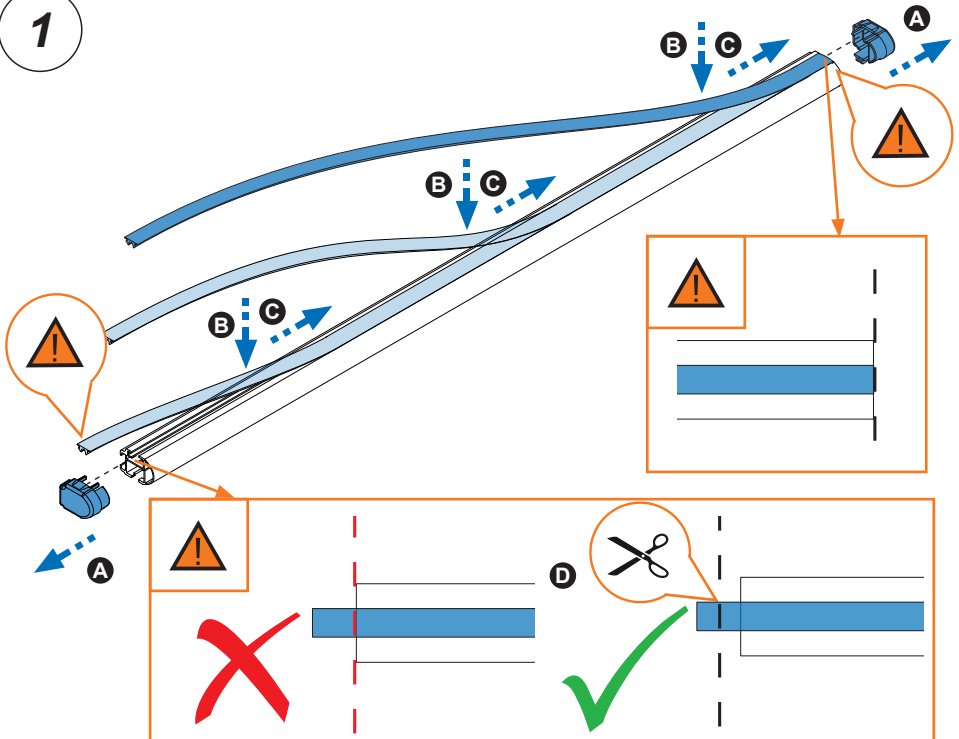

3. 

2

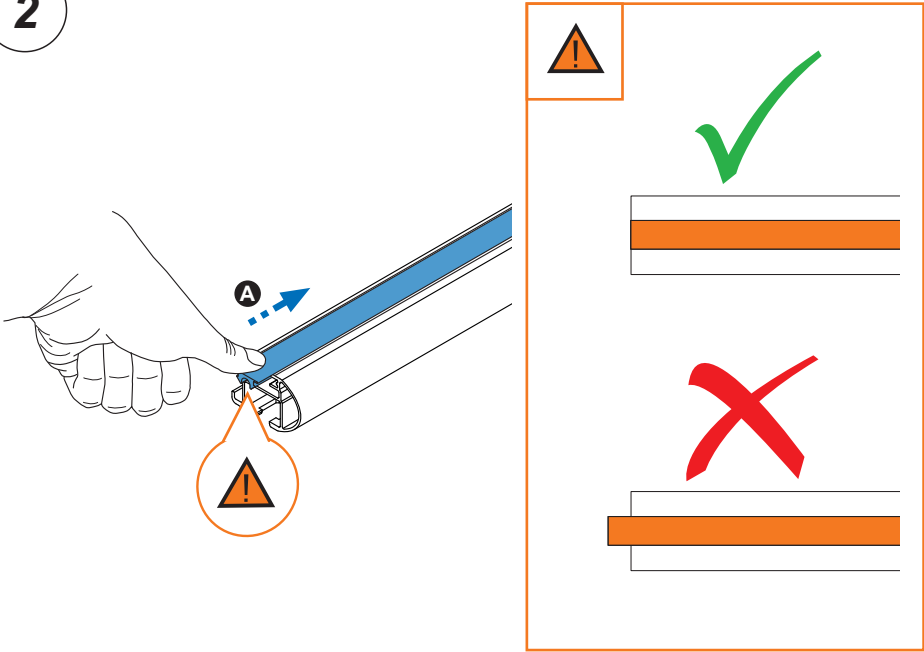

Diagram illustrating step 2 of the installation process. A hand is shown holding a blue extrusion profile. A blue arrow labeled 'A' points to the top edge of the profile. A red circle with a warning triangle points to the bottom edge of the profile. To the right, a box contains a warning triangle, a green checkmark above a white bar with an orange center, and a red 'X' above another white bar with an orange center.

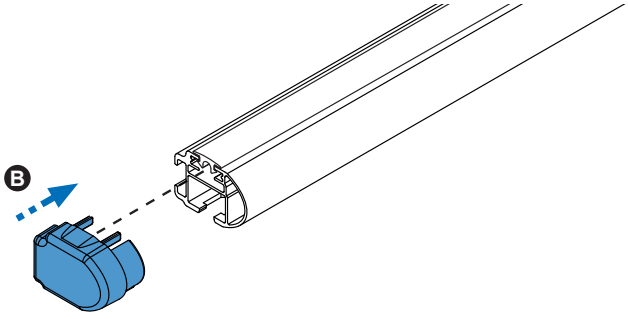

Diagram illustrating step 3 of the installation process. A blue extrusion profile is shown with a blue arrow labeled 'B' pointing to a blue component being inserted into the bottom edge.

3

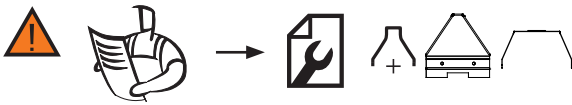

Diagram illustrating step 3 of the installation process. A warning triangle, a hand holding a document, an arrow, a wrench icon, a plus sign, and three different extrusion profiles are shown.