



935-414

Lv7 2019-r8

Modelo-model:

Optiplus

Lote-Lot-Lot-Lot:

01-10

Peso-Weight-Poids-Gewicht:

0,78 kg



Kit tipo (Certificación)
Kit type (Certification)
Kit type (Certificat)
Kit Typ (Zertifizierung)

A

CEE - EEC type approval:

E9 26 R- 03 3015

CRUZBER SA
ES-A14018311
P.I. Las Salinas II
14960 - Rute - Spain
www.cruzber.com

- | | | |
|--------------|---|-------------------------|
| (E) | Instrucción de montaje
¡Leer primero! | Kit fijación |
| (GB) | Assembly instructions
Read first! | Fixation Kit |
| (F) | Instruction de montage
Lire en premier! | Kit fixation |
| (D) | Montageanleitung
Zuerst lesen! | Stützfuß-Kit |
| (PT) | Instruções de montagem
Ler primeiro! | Kit fixação |
| (PL) | Instrukcja montażu
Najpierw przeczytaj! | Element mocujący |
| (CZ) | Montážní návod
Čtěte pozorně! | Fixační kit |
| (HU) | Szerelési Utasítás
Először olvassd el! | Rögzítő készlet |
| (RO) | Instructiuni de montaj
Intai cititi! | Kit de fixare |
| (HR) | Detaljne upute
Prvo pročitati! | Kit za montažu |
| (GR) | Διαβάστε προσεκτικά τις
Οδηγίες Συναρμολόγησης! | Κιβώτιο (Kit) Επισκευής |
| (TR) | Öncelikle montaj:
Talimatlarını okuyunuz! | Montaj kiti |
| (RU) | Инструкции по монтажу
Сначала прочитайте! | Крепёжный комплект |
| (I) | Istruzioni di montaggio
Leggere per primo! | Kit di fissaggio |
| (NL) | Montagehandleiding
Eerst lezen! | Bevestigingsset |
| (SLO) | Navodila za sestavljanje
Preberite! | Kit za pričvrstitev |



1.



x1



x1



(018-041)

x1



(810-045)

x4



1x (1072)
 1x (1073)
 1x (1074)
 1x (1075)

x4



2x (012-060)
 2x (012-070)

x1



(001-820)



Importante!
Important!
Important!
Wichtig!

(E) ¡Este Kit de fijación tiene que usarse con sistemas portacargas Cruz!

(GB) This fixation Kit must be used with Cruz roof rack systems!

(F) Cet Kit de fixation devra être utilisé avec les systèmes porte-charge Cruz!

(D) Dieser Stützfuß-Kit muß mit Cruz Dachträgersystemen benutzt werden!

(PT) Este Kit de fixação deve ser utilizado com os sistemas porta cargas Cruz!

(PL) Niniejszy element mocujący musi być używany z systemami bagażników dachowych firmy Cruz!

(CZ) Tento fixační kit musí být používán s nosným systémem Cruz!

(HU) Ez a rögzítő készlet csak a Cruz rendszerekkel használható!

(RO) Acest Kit de fixare, trebuie utilizat cu sisteme Cruz!

(HR) Kit za montažu mora biti korišten uz Cruz sistem krovnog nosača!

(GR) Το αξεσουάρ αυτό θα πρέπει να χρησιμοποιείται αποκλειστικά στα συστήματα μπαρών της Cruz!

(TR) Bu aksesuar mutlaka Cruz taşıma sistemleriyle kullanılmalıdır!

(RU) Крепежный комплект должен быть использован с багажной системой на крышу марки Cruz!

(IT) Questo kit di fissaggio deve essere usato con i portapacchi Cruz

(NL) Deze bevestigingsset moet worden gebruikt in combinatie met Cruz dakdrager systeem!

(SLO) Kit za pričvrstitev naj se uporablja le z izdelki iz asortimana strešnih košar Cruz!

2. 

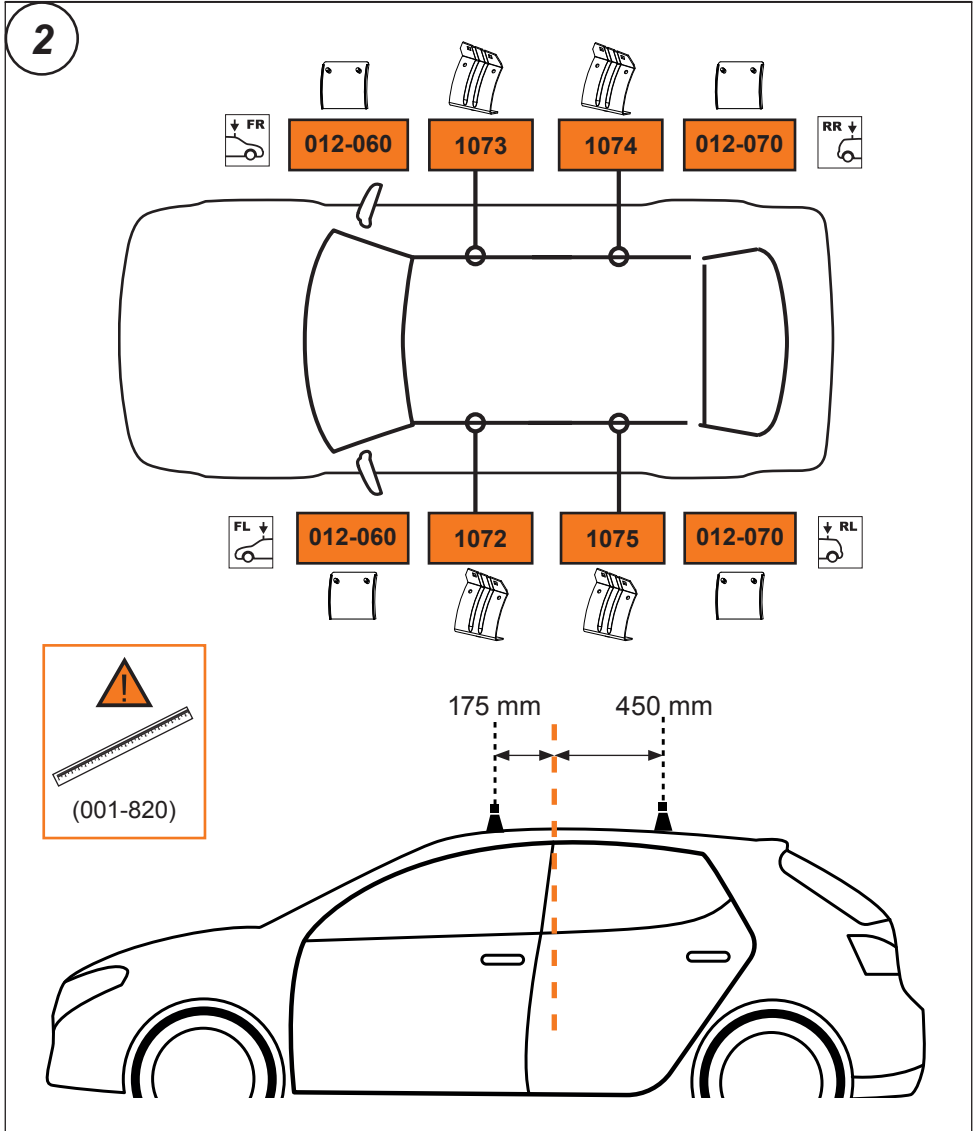

3. 

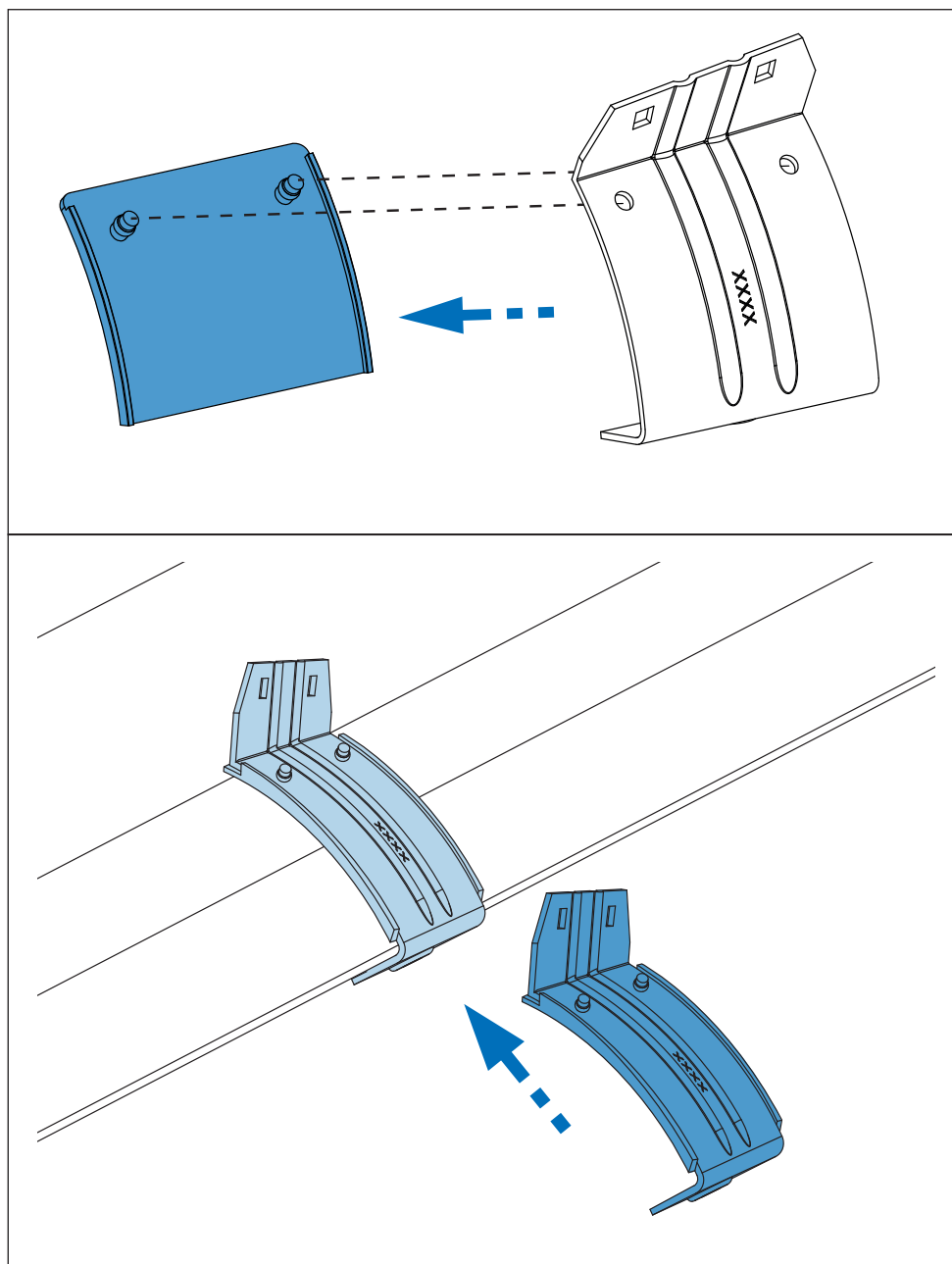

4. 

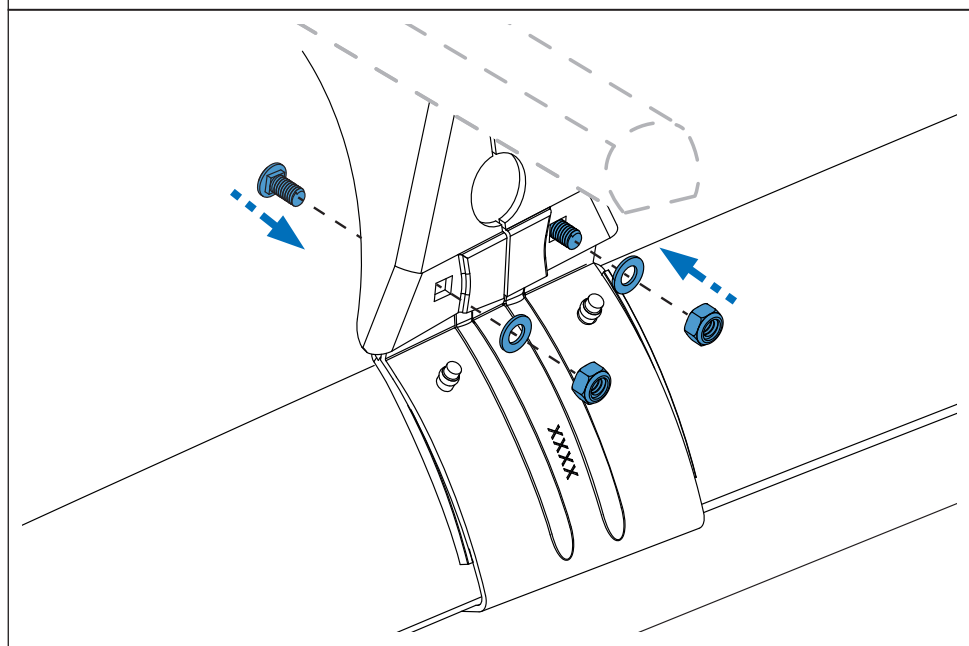
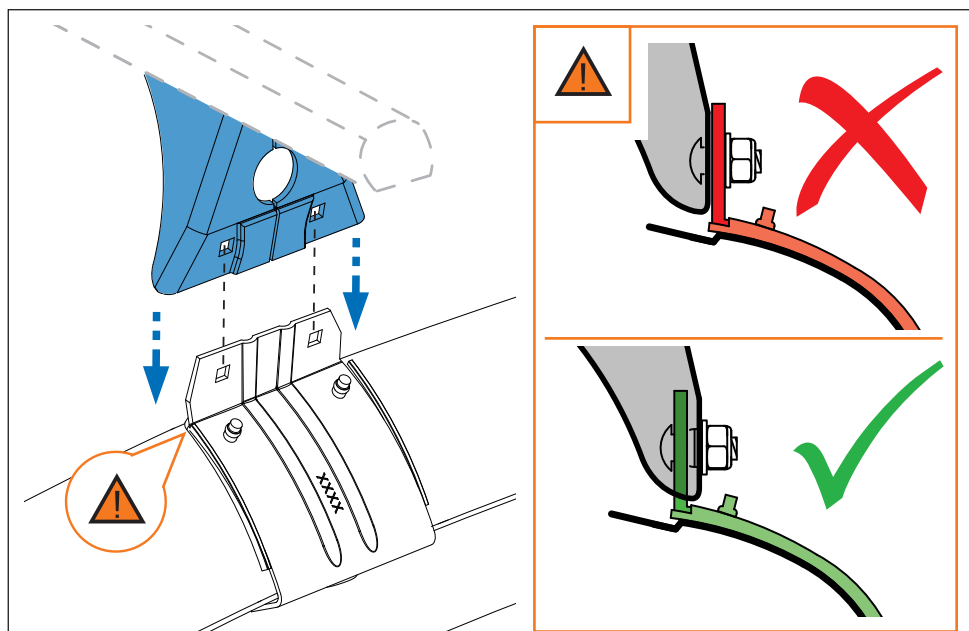

5. 

