



# 935-820

Lv7 2019-r3

Modelo-model:

## Optiplus

Lote-Lot-Lot-Lot:

**01-17**

Peso-Weight-Poids-Gewicht:

**0,95 kg**



Kit tipo (Certificación)  
Kit type (Certification)  
Kit type (Certificat)  
Kit Typ (Zertifizierung)

**A**

CEE - EEC type approval:

**E9** 26 R- 03 3015

CRUZBER SA  
ES-A14018311  
P.I. Las Salinas II  
14960 - Rute - Spain  
www.cruzber.com

<b>(E)</b>	<b>Instrucción de montaje</b> ¡Leer primero!	Kit fijación
<b>(GB)</b>	<b>Assembly instructions</b> Read first!	Fixation Kit
<b>(F)</b>	<b>Instruction de montage</b> Lire en premier!	Kit fixation
<b>(D)</b>	<b>Montageanleitung</b> Zuerst lesen!	Stützfuß-Kit
<b>(PT)</b>	<b>Instruções de montagem</b> Ler primeiro!	Kit fixação
<b>(PL)</b>	<b>Instrukcja montażu</b> Najpierw przeczytaj!	Element mocujący
<b>(CZ)</b>	<b>Montážní návod</b> Čtěte pozorně!	Fixační kit
<b>(HU)</b>	<b>Szerelési Utasítás</b> Először olvassd el!	Rögzítő készlet
<b>(RO)</b>	<b>Instructiuni de montaj</b> Intai cititi!	Kit de fixare
<b>(HR)</b>	<b>Detaljne upute</b> Prvo pročitati!	Kit za montažu
<b>(GR)</b>	<b>Διαβάστε προσεκτικά τις</b> Οδηγίες Συναρμολόγησης!	Κιβώτιο (Kit) Επισκευής
<b>(TR)</b>	<b>Öncelikle montaj:</b> Talimatlarını okuyunuz!	Montaj kiti
<b>(RU)</b>	<b>Инструкции по монтажу</b> Сначала прочитайте!	Крепежный комплект
<b>(I)</b>	<b>Istruzioni di montaggio</b> Leggere per primo!	Kit di fissaggio
<b>(NL)</b>	<b>Montagehandleiding</b> Eerst lezen!	Bevestigingsset
<b>(SLO)</b>	<b>Navodila za sestavljanje</b> Preberite!	Kit za pričvrstitev



1.



x1



x1



(018-041)

x2



(810-045)

x4



1x (2775)  
1x (2776)  
1x (2777)  
1x (2778)

x4



2x (012-080)  
2x (012-100)

x1



(001-820)



**Importante!**  
**Important!**  
**Important!**  
**Wichtig!**

**(E)** ¡Este Kit de fijación tiene que usarse con sistemas portacargas Cruz!

**(GB)** This fixation Kit must be used with Cruz roof rack systems!

**(F)** Cet Kit de fixation devra être utilisé avec les systèmes porte-charge Cruz!

**(D)** Dieser Stützfuß-Kit muß mit Cruz Dachträgersystemen benutzt werden!

**(PT)** Este Kit de fixação deve ser utilizado com os sistemas porta cargas Cruz!

**(PL)** Niniejszy element mocujący musi być używany z systemami bagażników dachowych firmy Cruz!

**(CZ)** Tento fixační kit musí být používán s nosným systémem Cruz!

**(HU)** Ez a rögzítő készlet csak a Cruz rendszerekkel használható!

**(RO)** Acest Kit de fixare, trebuie utilizat cu sisteme Cruz!

**(HR)** Kit za montažu mora biti korišten uz Cruz sistem krovnog nosača!

**(GR)** Το αξεσουάρ αυτό θα πρέπει να χρησιμοποιείται αποκλειστικά στα συστήματα μπαρών της Cruz!

**(TR)** Bu aksesuar mutlaka Cruz taşıma sistemleriyle kullanılmalıdır!

**(RU)** Крепежный комплект должен быть использован с багажной системой на крышу марки Cruz!

**(IT)** Questo kit di fissaggio deve essere usato con i portapacchi Cruz

**(NL)** Deze bevestigingsset moet worden gebruikt in combinatie met Cruz dakdrager systeem!

**(SLO)** Kit za pričvrstitev naj se uporablja le z izdelki iz asortimana strešnih košar Cruz!

## 2.

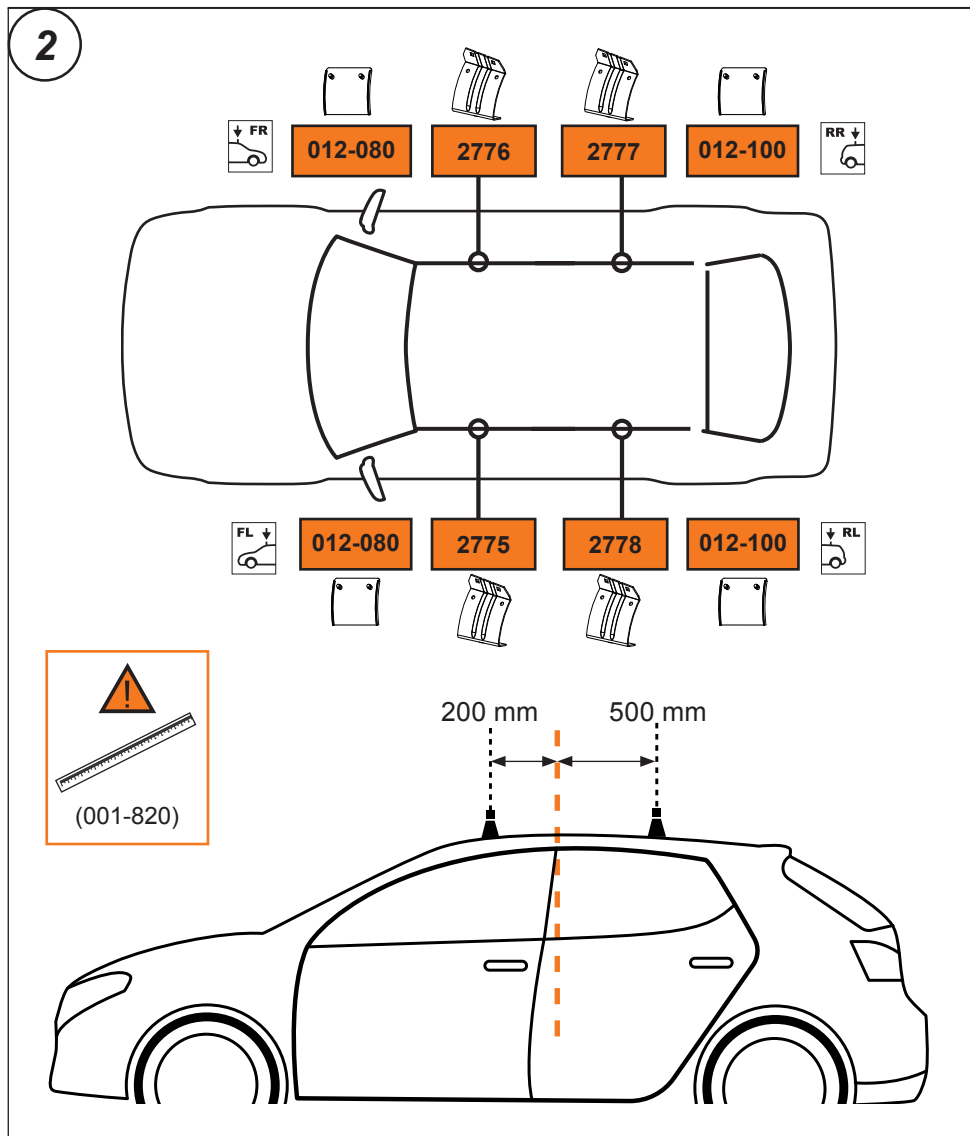

3. 

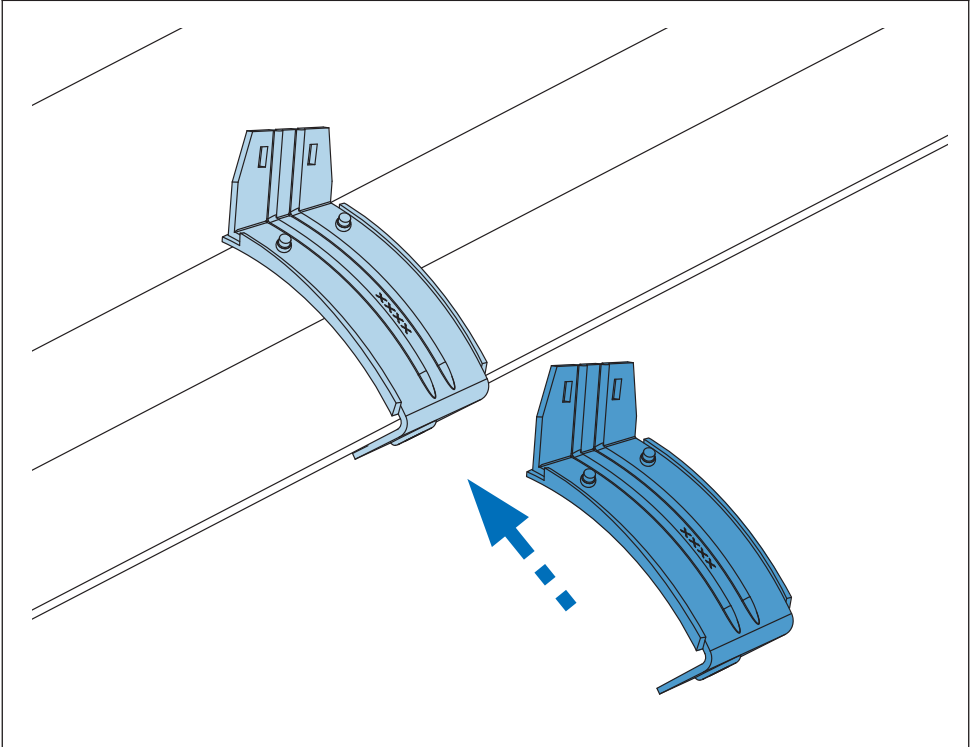
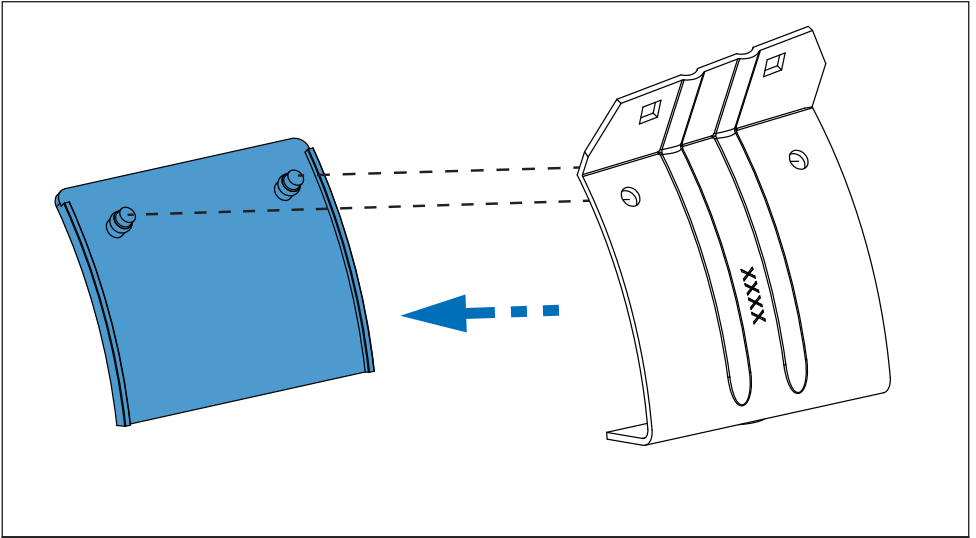

4. 

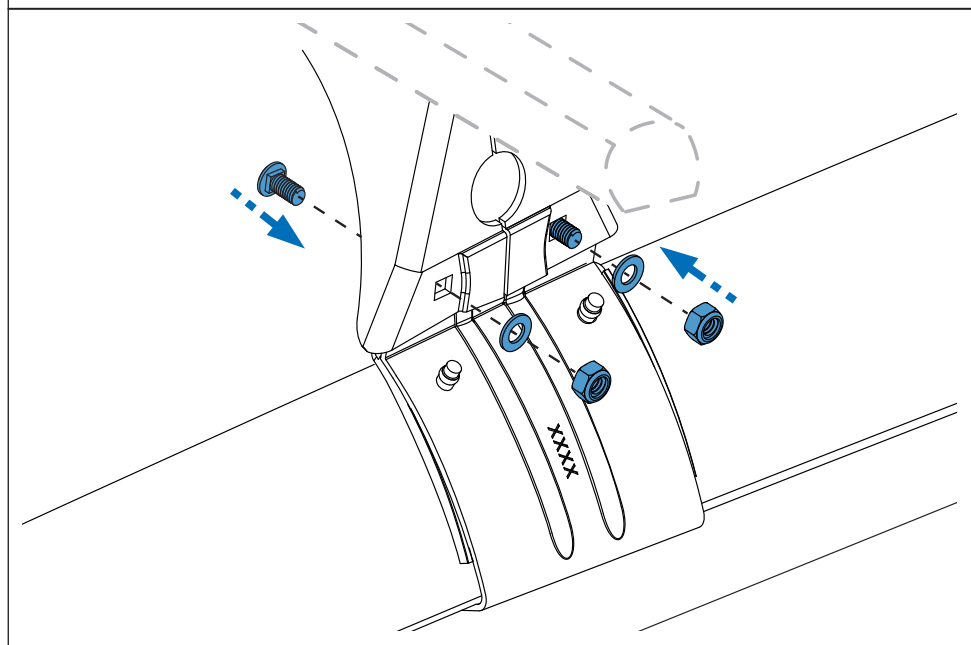
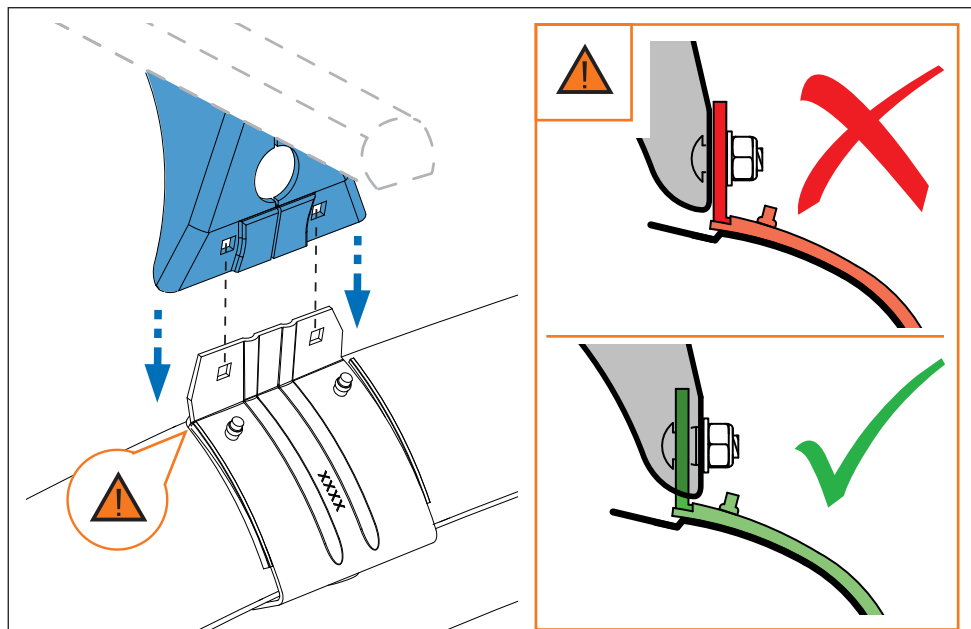

5. 

