

MODE 3 EV CHARGING CABLE

ITEM NO.: EV-1207
(Max. Power 3.6 kW)

STANDARDS/DIRECTIVES: EN 62196-1:2014
EN 62196-2:2017

REVISIONS

REV.	DESCRIPTION	DATE
A	Updating of cable specification	2020/06/08
B		

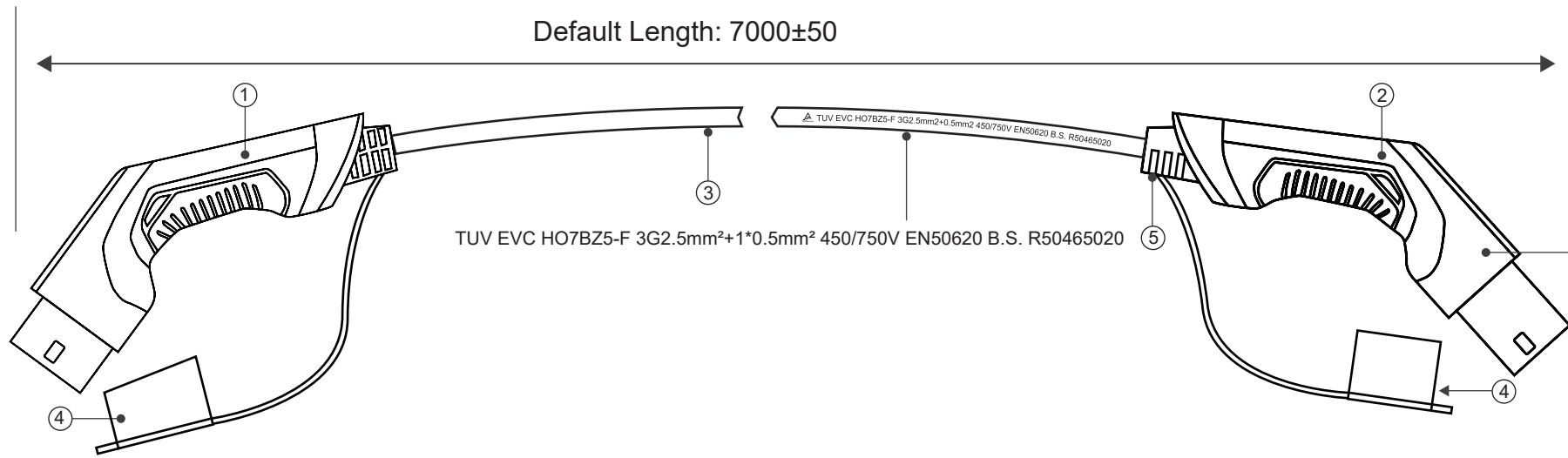

HEAT SENSOR
Both plugs have built-in temperature control. Once the set safe temperature is exceeded, the current will be cut off automatically.

SPECIFICATION

Current: Maximum 16A
Power Supply: 1-Phase
Operational Voltage: 220±10% AC
Protection Degree: IP54
Insulation Resistance: > 10MΩ
Insulator Flammability: UL94
Withstand Voltage: 2000V
Relative Humidity: 0-95% non-condensing
Maximum Altitude: < 2000M
Service Life: 10,000 times
Operating Temperature: - 40 °C ~ + 100 °C

IEC 62196-2 (TYPE 2-FEMALE)

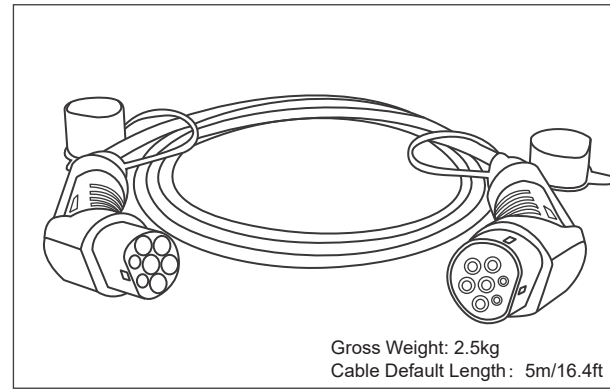
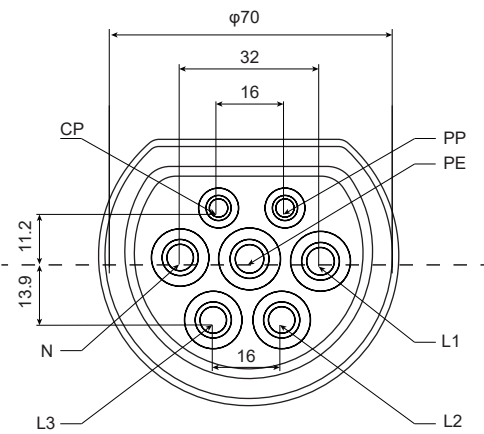

IEC 62196-2 (TYPE 2-MALE)

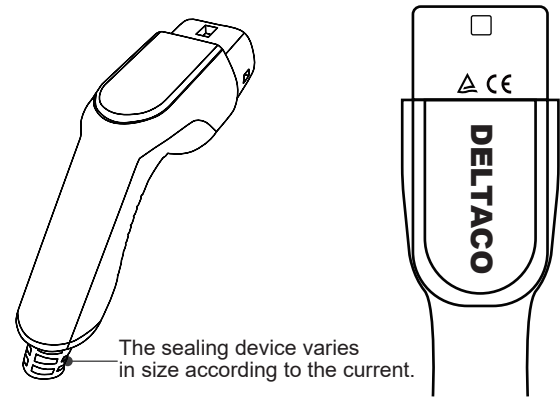
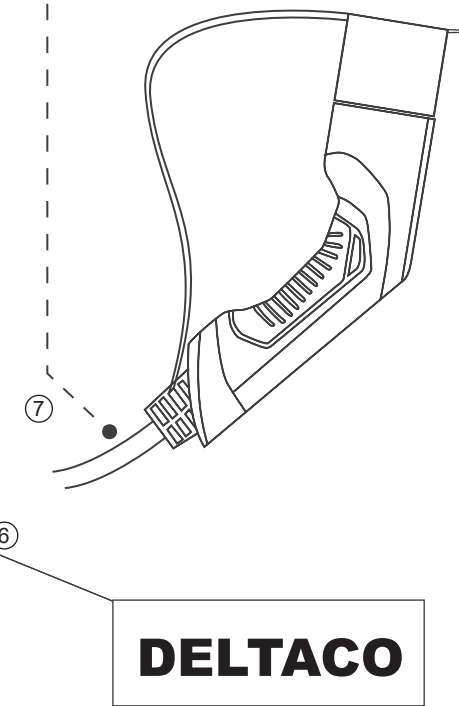
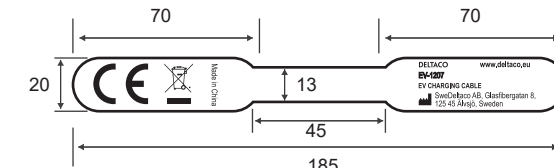
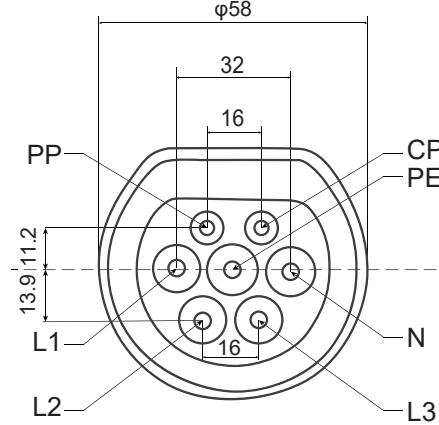

PRODUCT ADVANTAGES:

- Uniquely designed plug terminals with self-cleaning function to prevent electric sparks
- Silver-plated plug terminals with good conductivity to prevent over-heating
- Detection and control of inner temperature to ensure charging safety
- Integrated plug design with excellent waterproof performance to support outdoor use
- Solid plug structure can withstand the rolling of a vehicle

TYPE 2-FEMALE (IEC62196-2) CONNECTOR

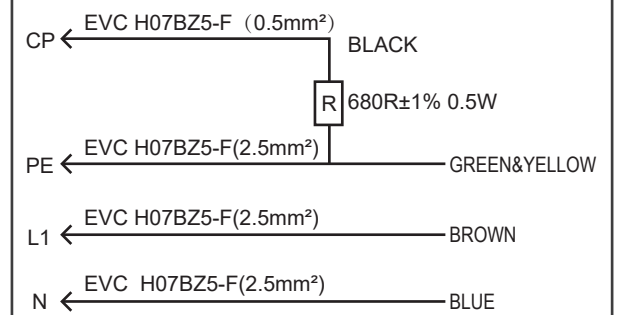

TYPE 2-MALE (IEC62196-2) CONNECTOR

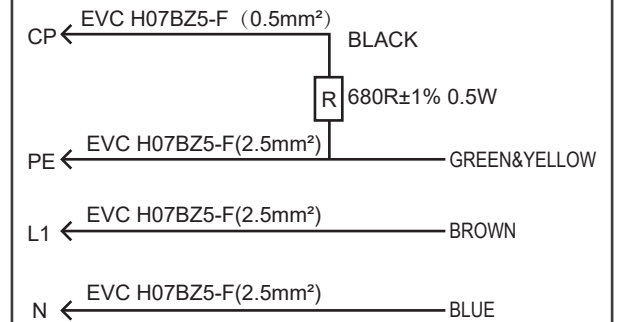

ITEM	DESCRIPTION	DEFAULT COLOR
①	Plug IEC 62196-2 (Type 2 - female)	BLACK
②	Plug IEC 62196-2 (Type 2 - male)	BLACK
③	TUV licensed EV charging cable	BLACK
④	Waterproof cover	BLACK
⑤	Sealing device	BLACK
⑥	Customized laser printed logo	GREY
⑦	Customized CE tag on cable	BLACK
⑧	Printed CE & TUV logo on plug	WHITE



SIGNATURE	
SAFETY ENGINEER	
MANAGER BY:	
CHECKED BY:	
DRAWN BY:	

DELTAACO	
ITEM NO.: EV-1207	DATE: 2020/06/06
UNIT: mm	SHEET: 1 OF 1
DWG NO: BSCNC01	
REV. A	